



Deutsch	5
English	16
Français	27
Italiano	39
Nederlands	50
Español	61
Português	72
Ελληνικά	83

Register and win!
www.kärcher.com/register-and-win



59663550 (08/14)



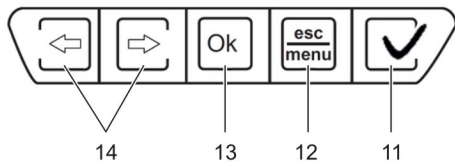
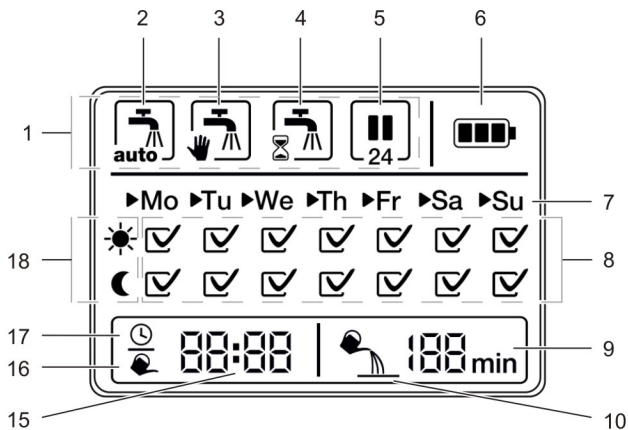

Inhaltsverzeichnis

Allgemeine Hinweise	5
Sicherheitshinweise	6
Bedienung	6
Pflege und Wartung	14
Hilfe bei Störungen	15
Technische Daten	15

Allgemeine Hinweise

Sehr geehrter Kunde,



Lesen Sie vor der ersten Benutzung Ihres Gerätes diese Originalbetriebsanleitung, handeln Sie danach und bewahren Sie diese für späteren Gebrauch oder für Nachbesitzer auf.

Bestimmungsgemäße Verwendung

- Dieses Gerät wurde für den privaten Gebrauch entwickelt und ist nicht für die Beanspruchungen des gewerblichen Einsatzes vorgesehen.
- Dieses Gerät ist zum Anschluss an einen Wasserhahn vorgesehen und steuert automatisch den Wasserfluss in Bewässerungssystemen.

Umweltschutz



Die Verpackungsmaterialien sind recyclebar. Bitte werfen Sie die Verpackungen nicht in den Hausmüll, sondern führen Sie diese einer Wiederverwertung zu.



Altgeräte enthalten wertvolle recyclingfähige Materialien, die einer Verwertung zugeführt werden sollten. Bitte entsorgen Sie Altgeräte deshalb über geeignete Sammelsysteme.

Hinweise zu Inhaltsstoffen (REACH)

Aktuelle Informationen zu Inhaltsstoffen finden Sie unter:

www.kaercher.de/REACH

Garantie

In jedem Land gelten die von unserer zuständigen Vertriebsgesellschaft herausgegebenen Garantiebedingungen. Etwaige Störungen an Ihrem Gerät beseitigen wir innerhalb der Garantiefrist kostenlos, sofern ein Material- oder Herstellungsfehler die Ursache sein sollte. Im Garantiefall wenden Sie sich bitte mit Kaufbeleg an Ihren Händler oder die nächste autorisierte Kundendienststelle.
(Adresse siehe Rückseite)

Symbole in der Betriebsanleitung

VORSICHT

Für eine möglicherweise gefährliche Situation, die zu leichten Verletzungen oder zu Sachschäden führen kann.

Sicherheitshinweise

VORSICHT

- *Bewässerungsautomat nicht in Trinkwassersystemen betreiben.*
- *Bewässerungsautomat nur mit unbehandeltem, klarem Süßwasser mit einer Temperatur bis maximal 35°C betreiben.*
- *Bewässerungsautomat nur im Außenbereich installieren.*
- *Bewässerungsautomat keinem direkten Wasserstrahl aussetzen und nie in Wasser tauchen.*
- *Bewässerungsautomat vor jedem Betrieb auf Schäden prüfen, bei sichtbaren Beschädigungen Betrieb einstellen.*
- *Bewässerungsautomat nur in vertikaler Position anbringen.*
- *Keine Dichtmasse und keine Schmiermittel verwenden, um den Bewässerungsautomat am Wasserhahn anzuschließen.*
- *Nicht am angeschlossenen Schlauch ziehen.*
- *Nur 9V Batterien (Typ 6LR61) verwenden.*
- *Bewässerungsautomat nicht an Orten installieren, an denen sich Kondenswasser bildet, da hierdurch die Batterie beschädigt werden kann.*
- *Bewässerungsautomat nicht in der Nähe von Wärmequellen installieren (maximale Umgebungstemperatur 60°C).*
- *Bewässerungsautomat nicht in der Nähe von unter Spannung stehenden Geräten betreiben.*

Bedienung

Prüfen Sie beim Auspacken den Packungsinhalt auf Vollständigkeit und Beschädigungen. Benachrichtigen Sie bei Beanstandungen bitte Ihren Händler.

Abbildungen siehe Ausklappseite!



Gerätebeschreibung

Abbildungen siehe Seite 2

- 1 Reduzierstück (G $\frac{3}{4}$)
- 2 Wasseranschluss (G 1) mit Filterdichtung
- 3 Ventileinheit
- 4 Schlauchanschluss
- 5 Kupplungsteil für Schlauchanschluss
- 6 Bedieneinheit
- 7 Batteriefach
- 8 Display
- 9 Tastenfeld

Displaybeschreibung

Abbildungen siehe Seite 3

- 1 Menüleiste
- 2 Automatische Bewässerung
- 3 Manuelle Bewässerung
- 4 Countdown-Funktion Bewässerung
- 5 Unterbrechung Bewässerung
- 6 Batteriestatus Bedieneinheit
- 7 Anzeige Wochentag
- 8 Anzeige Bewässerungsprogramm (aktiviert/deaktiviert)
- 9 Bewässerungsdauer
- 10 Anzeige Bewässerung ist aktiv
- 11 Bestätigungstaste Aktivierung/Deaktivierung Bewässerung
- 12 menu / esc-Taste
- 13 ok-Taste
- 14 Pfeiltasten
- 15 Uhrzeit / Bewässerungszeit
- 16 Anzeige Bewässerungszeit
- 17 Anzeige aktuelle Zeit
- 18 Bewässerungszeitraum (morgens/abends)

Funktion

Dem Gerät stehen 4 Modi zur Verfügung.

Automatische Bewässerung

- Mit dieser Funktion können Bewässerungszeiträume individuell eingestellt werden und die Bewässerung wird automatisch aktiviert und deaktiviert.

Manuelle Bewässerung

- Mit dieser Funktion wird die Bewässerung manuell ein- oder ausgeschaltet.

Countdown-Funktion Bewässerung

- Mit dieser Funktion wird die Bewässerung nach einer gewünschten Zeit (max. 120 Minuten) automatisch abgeschaltet.

Unterbrechung der Bewässerung

- Mit dieser Funktion wird die automatische Bewässerung für 24 Stunden ausgesetzt.



Vor Inbetriebnahme

- ➔ Wasserhahn muss geschlossen sein.
- ➔ Kupplungsteil auf Schlauchanschluss schrauben.
- ➔ Bei Bedarf Reduzierstück auf Wasseranschluss schrauben.
- ➔ Ventileinheit am Gehäuse halten und Wasseranschluss auf den Wasserhahn schrauben.





VORSICHT

Bewässerungsautomat nie ohne mitgelieferte Filterdichtung an den Wasserhahn anschließen.

Vorbereitung Bedieneinheit

	<p>Hinweis: Die Batterie ist nicht im Lieferumfang enthalten.</p> <p>➔ Batterie lagerichtig (+/- Kennzeichnung) in das Batteriefach einlegen.</p>
	<p>■ Sobald die Batterie eingelegt ist, wechselt die Anzeige, nach kurzem Selbsttest, direkt in den Einstellmodus für die aktuelle Uhrzeit und den Wochentag. Es blinken die Stunden der Anzeige Uhrzeit.</p>

Uhrzeit einstellen bei Erstinbetriebnahme







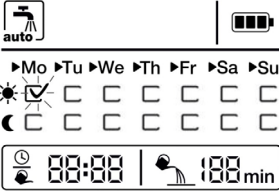

	<p>Hinweis: Sobald die Batterie eingelegt wurde, blinkt die Uhrzeit automatisch.</p>
	<p>➔ Die Stunden mit den Pfeiltasten einstellen.</p>
	<p>➔ Mit ok-Taste bestätigen.</p> <p><i>Es blinken die Minuten.</i></p>
	<p>➔ Die Minuten mit den Pfeiltasten einstellen.</p>
	<p>➔ Mit ok-Taste bestätigen.</p> <p>■ Die Uhrzeit ist eingestellt.</p>

Wochentag einstellen bei Erstinbetriebnahme





<p>►Mo Tu We Th Fr Sa Su</p> <p>☀ ☾</p>	<p>Anzeige: Montag bis Sonntag</p>
<p>← →</p>	<p>→ Den Wochentag mit den Pfeiltasten einstellen.</p>
<p>Ok</p>	<p>→ Mit ok-Taste bestätigen.</p> <p>■ Der Wochentag ist eingestellt.</p>

Einstellung automatische Bewässerung









	<p><i>Es blinkt die Anzeige Bewässerung (aktiviert)</i></p> <p>Hinweis Die Werkseinstellung für die Bewässerungszeit und -dauer sind morgens 6:00, 5 Minuten und abends 21:00, 5 Minuten.</p>
<p>← →</p>	<p>Mit den Pfeiltasten kann durch das Bewässerungsprogramm navigiert werden.</p>
<p>✓</p>	<p>→ Mit Bestätigungstaste Aktivierung/Deaktivierung Bewässerung markieren.</p> <p>Wenn voreingestellte Uhrzeit und Dauer in Ordnung sind, können mit den Pfeiltasten weitere Bewässerungszeiträume ausgewählt werden.</p> <p>Hinweis Mit esc/menu-Taste kann der Einstellmodus jederzeit verlassen werden.</p>

	<p>Wenn voreingestellte Uhrzeit und Dauer nicht in Ordnung sind: → Mit ok-Taste bestätigen, um die Uhrzeit und Dauer des aktiven Bewässerungszeitraums zu ändern.</p> <p><i>Es blinken die Stunden.</i></p>
	<p>→ Die Stunden mit den Pfeiltasten einstellen.</p>
	<p>→ Mit ok-Taste bestätigen.</p> <p><i>Es blinken die Minuten.</i></p>
	<p>→ Die Minuten mit den Pfeiltasten einstellen.</p>
	<p>→ Mit ok-Taste bestätigen.</p> <p><i>Es blinkt die Bewässerungsdauer.</i></p>
	<p>→ Die Minuten mit den Pfeiltasten einstellen.</p>
	<p>→ Mit ok-Taste bestätigen.</p> <ul style="list-style-type: none"> ■ Die Bewässerungsdauer ist eingestellt. ■ Es können nun weitere Bewässerungszeiträume mit den Pfeiltasten eingestellt werden.
	<p>→ Mit esc/menu-Taste den Einstellmodus verlassen.</p> <p><i>Automatische Bewässerung ist aktiviert.</i></p>
<p>Hinweis Zur späteren Änderung der Einstellungen mit esc/menu-Taste und den Pfeiltasten in den Einstellmodus der automatischen Bewässerung wechseln.</p>	





Einstellung manuelle Bewässerung

	<p>→ Mit esc/menu-Taste in den Einstellmodus wechseln.</p>
	<p><i>Es blinkt das Symbol für manuelle Bewässerung.</i></p>
	<p>→ Mit ok-Taste bestätigen.</p>
	<p><i>Es erscheint das Bewässerungssymbol.</i></p> <ul style="list-style-type: none"> ■ Das Ventil öffnet. ■ Bewässerung ist aktiv.
	<p>→ Mit esc/menu-Taste schließt das Ventil und es wird in den Automatikmodus gewechselt.</p> <p>→ Mit ok-Taste schließt das Ventil, es wird in den Einstellmodus gewechselt und es kann eine neue Funktion ausgewählt werden.</p>

Einstellung Countdown-Funktion Bewässerung

	<p>→ Mit esc/menu-Taste in den Einstellmodus wechseln.</p>
	<p>→ Bewässerungsmodus mit den Pfeiltasten auswählen.</p>
	<p><i>Es blinkt das Symbol für die Countdown-Funktion.</i></p>
	<p>→ Mit ok-Taste bestätigen.</p> <p><i>Es blinken die Minuten.</i></p>
	<p>→ Die Minuten mit den Pfeiltasten einstellen.</p>
	<p>→ Mit ok-Taste bestätigen.</p>
	<p><i>Es erscheint das Bewässerungssymbol.</i></p> <ul style="list-style-type: none"> ■ Die Countdown-Funktion ist aktiviert. ■ Das Ventil öffnet. ■ Bewässerung ist aktiv. <p><i>Nach Ablaufzeit des Countdowns wechselt die Funktion in den Automatikmodus.</i></p>
	<p>Für vorzeitiges Beenden:</p> <p>→ Mit esc/menu-Taste schließt das Ventil und es wird in den Automatikmodus gewechselt.</p> <p>→ Mit ok-Taste schließt das Ventil, es wird in den Einstellmodus gewechselt und es kann eine neue Funktion ausgewählt werden.</p>

Unterbrechung Bewässerung

	→ Mit esc/menu-Taste in den Einstellmodus wechseln.
	→ Bewässerungsmodus mit den Pfeiltasten auswählen.
	<i>Es blinkt das Symbol für die Unterbrechung der Bewässerung.</i>
	→ Mit ok-Taste bestätigen. ■ Die Bewässerungseinstellung ist für 24 Stunden deaktiviert.
	→ Für ein Beenden vor Ablauf der 24 Stunden kann mit ok-Taste oder esc/menu-Taste die Funktion unterbrochen werden und es wird in den Automatikmodus gewechselt.

Betrieb

- Bedieneinheit auf Ventileinheit setzen.
- Wasserhahn öffnen.

Betrieb beenden

Am Ende der Bewässerungssaison



- Wasserhahn schließen.
- Bewässerungsautomat von Wasserhahn und Wasserschlauch trennen.
- Bedieneinheit muss mit Ventileinheit verbunden bleiben.
- Manuelle Bewässerung aktivieren, damit restliches Wasser aus dem Bewässerungsautomaten abfließen kann.
- Bedieneinheit von Ventileinheit trennen.
- Batterie entfernen.
- Bewässerungsautomat an einem trockenen und frostsicheren Ort lagern.

Pflege und Wartung

Filterdichtung reinigen

- ➔ Filterdichtung im Wasseranschluss regelmäßig entnehmen und unter fließendem Wasser ausspülen.

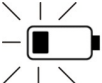
Batterie

	Batteriestatus voll
	Batteriestatus fast leer ➔ Batterie erneuern.
	Batteriestatus leer ➔ Batterie erneuern. Hinweis Im Modus automatische Bewässerung wird das Ventil zur Sicherheit geschlossen. Die Bewässerung kann nicht mehr aktiviert werden.

Batterie wechseln

- ➔ Bedieneinheit abnehmen.
- ➔ Neue 9V Batterie (Typ 6LR61) einlegen.
Verbrauchte Batterie gemäß den geltenden Bestimmungen entsorgen.
- ➔ Bedieneinheit auf Ventileinheit setzen, auf richtigen Sitz achten.

Hinweis

Die alte Batterie kann innerhalb von 3 Minuten durch eine neue Batterie ersetzt werden, ohne dass die Bewässerungseinstellungen und Programmierung verloren gehen.

Verwendbare Batterietypen:

- Alkaline
- Wiederaufladbare Batterie mit geringer Selbstentladung und mit mindestens 250 mAh Kapazität.

Hinweis

Wiederaufladbare Batterien halten unter Umständen keine ganze Saison.

Wartung

Das Gerät ist wartungsfrei.

Hilfe bei Störungen

Störung	Ursache	Behebung
Bewässerung erfolgt trotz Programmierung nicht.	Wasserhahn geschlossen.	Wasserhahn öffnen.
	Batterie leer.	Neue 9V Batterie (Typ 6LR61) einlegen.
	Batterieanschlusskontakte oxidiert.	Kontakte reinigen.
	Filterdichtung verstopft.	Filterdichtung reinigen.
Ventil öffnet / schließt nicht.	Bei abgenommener Bedieneinheit kann Ventil nicht öffnen /schließen.	Bedieneinheit an die Ventileinheit anbringen.
Keine Display-Anzeige	Batterie leer oder Kontakte oxidiert.	Neue 9V Batterie (Typ 6LR61) einlegen oder Kontakte reinigen.
Leckage am Wasseranschluss.	Filterdichtung defekt.	Filterdichtung ersetzen.
	Wasseranschluss am Wasserhahn hat sich gelöst.	Wasseranschluss wieder festschrauben.

Bei Fragen oder Störungen hilft Ihnen unsere Kärcher-Niederlassung gerne weiter. Adresse siehe Rückseite.

Reset durchführen

→ Batterie aus dem Batteriefach nehmen, bis die Anzeige im Display vollständig erloschen ist.

oder

→ Durch 5 Sekunden drücken der ok-Taste werden die Einstellung zurückgesetzt.

Technische Daten

Betriebsdruck	0,1 - 1,0 (1 - 10)	MPa (bar)
Zulauftemperatur (max.)	35	°C
Umgebungstemperatur	+1 -> +60	°C
Batterietyp	9V (6LR61 / Alkaline)	
	9V (Baugröße wie: 6LR61 / Wiederaufladbare Batterie mit geringer Selbstentladung und mindestens 250 mAh)	

Technische Änderungen vorbehalten.

Contents

General information	16
Safety instructions	17
Operation	17
Maintenance and care	25
Troubleshooting	26
Technical specifications	26

General information

Dear Customer,



Please read and comply with these original instructions prior to the initial operation of your appliance and store them for later use or subsequent owners.

Proper use

- This appliance has been designed for use in private households and is not intended for commercial use.
- This appliance is designed to be connected to a water tap and automatically regulates the water flow in irrigation systems.

Environmental protection



The packaging material can be recycled. Please do not place the packaging into the ordinary refuse for disposal, but arrange for the proper recycling.



Old appliances contain valuable materials that can be recycled. Please arrange for the proper recycling of old appliances. Please dispose your old appliances using appropriate collection systems.

Information on ingredients (REACH)

The latest information on ingredients can be found at:

www.kaercher.de/REACH

Warranty

The warranty terms published by the relevant sales company are applicable in each country. We will repair potential failures of your appliance within the warranty period free of charge, provided that such failure is caused by faulty material or defects in manufacturing. In the event of a warranty claim please contact your dealer or the nearest authorized Customer Service centre. Please submit the proof of purchase. (See address on the reverse)

Symbols in the operating instructions

CAUTION

For a possibly dangerous situation which can lead to minor injuries or property damage.

Safety instructions

CAUTION

- Do not use the irrigation device in drinking water systems.
- Only operate the irrigation device with untreated, clear fresh water with a temperature of max. 35°C.
- Only install the device outside.
- Do not expose the watering device to a direct water jet and never immerse it in water.
- Check the irrigation device for damages prior to each use and stop using it if there are visual damages.
- Only mount irrigation device in a vertical position.
- Do not use sealant or lubrication to connect the irrigation device to the water tap.
- Do not pull on the connected hose.
- Only use 9V batteries (type 6LR61).
- Do not install the irrigation device in areas where condensation water may be generated, as this may damage the battery.
- Do not install the watering device near heat sources (max. ambient temperature 60°C).
- Do not install the irrigation device near powered devices.

Operation

Check the contents of the packaging for completeness and damages when unpacking. If you detect any damages please contact your dealer.

Illustrations on fold-out page!



Description of the Appliance

Illustrations on Page 2

- 1 Reduction piece (G 3/4)
- 2 Water connection (G 1) with filter gasket
- 3 Valve unit
- 4 Hose connection
- 5 Coupling element for hose connection
- 6 Control unit
- 7 Battery compartment
- 8 Display
- 9 Keypad

Description of the display

Illustrations on Page 3

- 1 Menu bar
- 2 Automatic irrigation
- 3 Manual irrigation
- 4 Countdown function watering
- 5 Interruption watering
- 6 Battery status control unit
- 7 Display day of the week
- 8 Display watering programme (activated/deactivated)
- 9 Irrigation duration
- 10 Display watering is active
- 11 Confirmation button activation/deactivation watering
- 12 menu / esc button
- 13 OK button
- 14 Arrow keys
- 15 Time / time of irrigation
- 16 Display watering time
- 17 Display current time
- 18 Watering period (in the morning/evening)

Function

The device has 4 modes at disposal.

Automatic irrigation

- With this function watering periods can be set individually and the watering is automatically activated and deactivated.

Manual irrigation

- With this function the watering is manually switch on or off.

Countdown function watering

- With this function the watering is automatically switched off after a desired period of time (max. 120 minutes).

Interruption of the watering

- With this function the automatic watering is intermitted for 24 hours.



Before Startup

- ➔ The tap must be closed.
- ➔ Screw the coupling element onto the hose connection.
- ➔ If necessary, screw the reduction piece onto the water connection.
- ➔ Hold the valve unit on the casing and screw the water connection onto the water tap.





CAUTION

Never connect the watering device to the water tap without using the supplied filter seal.

Preparation control unit

	<p>Note: The battery is not included in the scope of delivery.</p> <p>➔ Insert the battery into the battery compartment in the correct position (+/- marking).</p>
	<p>■ As soon as the battery is inserted, the display changes directly into the settings mode for the current time and day of the week after a short self-test. The hours of the time display are flashing.</p>

Setting the time upon initial start-up









	<p>Note: As soon as the battery is inserted, the time flashes automatically.</p>
	<p>➔ Set the hours by means of the arrow keys.</p>
	<p>➔ Confirm with the OK button.</p> <p><i>The minutes are flashing.</i></p>
	<p>➔ Set the minutes by means of the arrow keys.</p>
	<p>➔ Confirm with the OK button.</p> <p>■ The time is set.</p>

Setting the day of the week upon initial start-up

<p>▶Mo Tu We Th Fr Sa Su</p> <p>☀</p> <p>☾</p>	<p>display: Monday through Sunday</p>
<p>← →</p>	<p>→ Set the day of the week using the arrow keys.</p>
<p>Ok</p>	<p>→ Confirm with the OK button.</p> <p>■ The day of the week is set.</p>

Setting automatic watering





 <p>▶Mo ▶Tu ▶We ▶Th ▶Fr ▶Sa ▶Su</p> <p>☀ <input checked="" type="checkbox"/> <input type="checkbox"/> <input type="checkbox"/> <input type="checkbox"/> <input type="checkbox"/> <input type="checkbox"/> <input type="checkbox"/></p> <p>☾ <input type="checkbox"/> <input type="checkbox"/> <input type="checkbox"/> <input type="checkbox"/> <input type="checkbox"/> <input type="checkbox"/> <input type="checkbox"/></p> <p>🕒 00:00 🕒 00 min</p>	<p><i>The display watering (activated) is flashing</i></p> <p>Note The factory setting for the watering time and duration is 5 minutes at 6 a.m. and 5 minutes at 9 p.m.</p>
<p>← →</p>	<p>You can navigate through the watering programme using the arrow keys.</p>
<p>☑</p>	<p>→ Mark activation/deactivation watering using the confirmation button.</p> <p>If the preset time and duration is OK, further watering periods can be selected using the arrow keys.</p> <p>Note The settings mode can be left with the esc/ menu button at any time.</p>

	<p>If the preset time and duration is not OK: → Confirm using the OK button to change the time and the duration of the active watering period.</p> <p><i>The hours are flashing.</i></p>
	<p>→ Set the hours by means of the arrow keys.</p>
	<p>→ Confirm with the OK button.</p> <p><i>The minutes are flashing.</i></p>
	<p>→ Set the minutes by means of the arrow keys.</p>
	<p>→ Confirm with the OK button.</p> <p><i>The watering duration is flashing.</i></p>
	<p>→ Set the minutes by means of the arrow keys.</p>
	<p>→ Confirm with the OK button.</p> <ul style="list-style-type: none"> ■ The watering duration is set. ■ Further watering periods can be set using the arrow keys.
	<p>→ Leave the settings mode using the esc/ menu button.</p> <p><i>Automatic watering is activated.</i></p>















Note

Switch into the settings mode of the automatic watering using the esc/menu button and the arrow keys for later changes of the settings.











Setting of manual watering

	<p>→ Switch into the settings mode using the esc/menu button.</p>
	<p><i>The symbol for manual watering is flashing.</i></p>
	<p>→ Confirm with the OK button.</p>
	<p><i>The watering symbol appears.</i></p> <ul style="list-style-type: none"> ■ The valve opens. ■ Watering is active.
	<p>→ The valve is closed with the esc/menu button and is switched into the automatic mode.</p> <p>→ The valve is closed with the OK button, it is switched into the settings mode and a new function can be selected.</p>

Setting of the countdown function watering

	<p>→ Switch into the settings mode using the esc/menu button.</p>
 	<p>→ Select the watering mode with the arrow keys.</p>
   	<p><i>The symbol for the countdown function flashes.</i></p>
	<p>→ Confirm with the OK button.</p> <p><i>The minutes are flashing.</i></p>
 	<p>→ Set the minutes by means of the arrow keys.</p>
	<p>→ Confirm with the OK button.</p>
 	<p><i>The watering symbol appears.</i></p> <ul style="list-style-type: none"> ■ The countdown function is activated. ■ The valve opens. ■ Watering is active. <p><i>After completion of the countdown the function changes into the automatic mode.</i></p>
 	<p>For premature termination:</p> <p>→ The valve is closed with the esc/menu button and is switched into the automatic mode.</p> <p>→ The valve is closed with the OK button, it is switched into the settings mode and a new function can be selected.</p>

Interruption watering

	→ Switch into the settings mode using the esc/menu button.
 	→ Select the watering mode with the arrow keys.
   	<i>The symbol for the interruption of the watering is flashing.</i>
	→ Confirm with the OK button. ■ The irrigation settings are deactivated for 24 hours.
 	→ The function can be interrupted by using the OK button or the esc/menu button before the expiration of the 24 hours and changes into the automatic mode.

Operation

- Place control unit onto valve unit.
- Open tap.

Finish operation

At the end of the irrigation season



- Turn off tap.
- Remove the irrigation device from the water tap and the water hose.
- The control unit must remain connected to the valve unit.
- Activate manual irrigation to drain the remaining water from the irrigation device.
- Disconnect the control unit from the valve unit.
- Remove the battery.
- Store the irrigation device at a dry and frost-free location.

Maintenance and care

Clean the filter gasket

- ➔ Regularly remove the filter gasket from the water connection and rinse under running water.

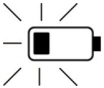
Battery

	Battery status full
	Battery status almost empty ➔ Replace battery.
	Battery status empty ➔ Replace battery. Note In the automatic watering mode the valve is closed for safety purposes. Watering can no longer be activated.

Change the battery

- ➔ Remove control unit.
- ➔ Insert a new 9V battery (type 6LR61).
Dispose of the used battery according to the local provisions.
- ➔ Place the control unit onto the valve unit, ensure proper seating.

Note

The old battery can be replaced by a new one within 3 minutes without losing the watering settings and programming.

Suitable battery types:

- Alkaline
- Rechargeable battery with low self-discharge and a minimum capacity of 250 mAh.

Note

Rechargeable batteries may not last an entire season.

Maintenance

The appliance is maintenance free.

Troubleshooting

Fault	Cause	Correction
The irrigation does not take place in spite of the programming.	Water tap is closed.	Open tap.
	Battery depleted.	Insert a new 9V battery (type 6LR61).
	Battery contacts oxidized.	Clean the contacts.
	Filter gaskets blocked.	Clean the filter gasket.
Valve does not open / close.	When the control unit is removed, the valve cannot open / close.	Attach the control unit to the valve unit.
No display indication	Battery empty or contacts oxidised.	Insert a new 9V battery (type 6LR61) or clean contacts.
Leakage at the water connection.	Filter gasket defective.	Replace the filter gasket.
	The water connection at the water tap has become loose.	Reconnect the water connection.

Our Kärcher branch will be pleased to help you further in the case of questions or faults. See address on the reverse.

Performing a reset

- Remove the battery from the battery compartment until the indication on the display has completely gone out.
- or
- The settings are reset by pressing the OK button for 5 seconds.

Technical specifications

Operating pressure	0,1 - 1,0 (1 - 10)	MPa (bar)
Max. feed temperature	35	°C
Ambient temperature	+1 -> +60	°C
Battery type	9V (6LR61 / Alkaline) 9V (size as: 6LR61 / Rechargeable battery with low self-discharge and at least 250 mAh)	

Subject to technical changes.

Table des matières

Consignes générales	27
Consignes de sécurité	28
Utilisation	28
Entretien et maintenance	36
Assistance en cas de panne	37
Caractéristiques techniques	38

Consignes générales

Cher client,



Lire cette notice originale avant la première utilisation de votre appareil, se comporter selon ce qu'elle requiert et la conserver pour une utilisation ultérieure ou pour le propriétaire futur.

Utilisation conforme

- Cet appareil ne doit être utilisé que pour un usage domestique.
- Le présent appareil est destiné au raccord à un robinet d'eau et pilote automatiquement le flux d'eau dans les systèmes d'arrosage.

Protection de l'environnement



Les matériaux constitutifs de l'emballage sont recyclables. Ne pas jeter les emballages dans les ordures ménagères, mais les remettre à un système de recyclage.



Les appareils usés contiennent des matériaux précieux recyclables lesquels doivent être apportés à un système de recyclage. Pour cette raison, utilisez des systèmes de collecte adéquats afin d'éliminer les appareils usés.

Instructions relatives aux ingrédients (REACH)

Les informations actuelles relatives aux substances se trouvent à l'adresse : www.kaercher.de/REACH

Garantie

Dans chaque pays, les conditions de garantie en vigueur sont celles publiées par notre société de distribution responsable. Les éventuelles pannes sur l'appareil sont réparées gratuitement dans le délai de validité de la garantie, dans la mesure où celles-ci relèvent d'un défaut matériel ou d'un vice de fabrication. En cas de recours en garantie, adressez-vous à votre revendeur ou au service après-vente agréé le plus proche munis de votre preuve d'achat.
(Adresse au dos)

Symboles utilisés dans le mode d'emploi

PRÉCAUTION

Signale la présence d'une situation éventuellement dangereuse pouvant entraîner des blessures légères ou des dommages matériels.

Consignes de sécurité

PRÉCAUTION

- Ne pas faire fonctionner l'arroseur automatique dans des systèmes d'eau potable.
- N'exploiter l'appareil d'arrosage qu'avec de l'eau claire non traitée, à une température maximale de 35°C.
- Installer l'arroseur automatique uniquement en zone extérieure.
- Ne pas soumettre l'arroseur automatique à un jet d'eau direct et ne pas le plonger dans l'eau.
- Contrôler avant chaque utilisation que l'arroseur automatique n'est pas endommagé ; l'arrêter en cas de dommages visibles.
- Disposer l'arroseur automatique uniquement en position verticale.
- Ne pas utiliser de mastic ni de lubrifiant pour raccorder l'arroseur automatique au robinet d'eau.
- Ne pas tirer sur le tuyau raccordé.
- Utiliser uniquement des piles 9V (type 6LR61).
- Ne pas installer l'arroseur automatique sur des sites où il se forme de la condensation d'eau car cela pourrait endommager la pile.
- Ne pas installer l'arroseur automatique près de sources de chaleur (température ambiante max. 60° C).
- Ne pas utiliser l'arroseur automatique à proximité d'appareils sous tension électrique.

Utilisation

Lors du déballage, contrôler la présence de l'intégralité du matériel et d'éventuels dommages. Si des dégâts imputables au transport sont constatés, il faut en informer le revendeur.

Illustrations, cf. côté escamotable !



Description de l'appareil

Illustrations voir page 2

- 1 Réducteur (G $\frac{3}{4}$)
- 2 Raccord d'eau (G1) avec joint filtre
- 3 Bloc de vannes
- 4 Raccord du tuyau
- 5 Élément de couplage pour raccord de tuyau
- 6 Unité de commande
- 7 Compartiment batterie
- 8 Ecran
- 9 Pavé de touches

Description de l'écran

Illustrations voir page 3

- 1 Barre de menus
- 2 Arrosage automatique
- 3 Arrosage manuel
- 4 Arrosage avec fonction compte à rebours
- 5 Interruption de l'arrosage
- 6 État de charge de la batterie Unité de commande
- 7 Affichage des jours de semaine
- 8 Affichage du programme d'arrosage (activé/désactivé)
- 9 Durée de l'arrosage
- 10 L'affichage de l'arrosage est actif
- 11 Touche de confirmation Activation/Désactivation de l'arrosage
- 12 Touche menu / esc
- 13 Touche OK
- 14 Touches de flèches
- 15 Heure / Heure d'arrosage
- 16 Affichage de la durée d'arrosage
- 17 Affichage de la durée actuelle
- 18 Période d'arrosage (matin/soir)

Fonctionnement

L'appareil dispose de 4 modes.

Arrosage automatique

- Avec cette fonction, des périodes d'arrosage peuvent être réglées individuellement et l'arrosage est automatiquement activé ou désactivé.

Arrosage manuel

- Avec cette fonction, l'arrosage est activé ou désactivé manuellement.

Arrosage avec fonction compte à rebours

- Avec cette fonction, l'arrosage est automatiquement arrêté après une durée définie (max. 120 minutes).

Interruption de l'arrosage

- Avec cette fonction, l'arrosage automatique est suspendu pendant 24 heures.



Avant la mise en service

- ➔ Le robinet d'eau doit être fermé.
- ➔ Visser l'élément de couplage sur le raccord de tuyau.
- ➔ Si nécessaire, visser le réducteur sur le raccord d'eau.
- ➔ Maintenir le bloc de vannes sur le boîtier et visser le raccord d'alimentation en eau sur le robinet d'eau.





PRÉCAUTION

Ne jamais raccorder l'arroseur automatique au robinet d'eau sans le joint de filtre fourni.



Préparation de l'unité de commande

	<p>Remarque : La batterie n'est pas comprise dans l'étendue de livraison.</p> <p>➔ Positionner correctement la batterie (marques +/-) dans le compartiment pour batteries.</p>
	<p>■ Dès que la batterie est installée, l'affichage passe directement, après un bref auto-contrôle, dans le mode de réglage pour l'heure actuel et le jour de semaine actuel. Les heures de l'affichage Heure clignotent.</p>



Régler l'heure à la première mise en service









	<p>Remarque : Dès que la batterie est mise en place, l'heure clignote automatiquement.</p>
	<p>➔ Régler les heures avec les flèches.</p>
	<p>➔ Confirmer avec la touche OK.</p> <p><i>Les minutes clignotent.</i></p>
	<p>➔ Régler les minutes avec les flèches.</p>
	<p>➔ Confirmer avec la touche OK.</p> <p>■ L'heure est réglée.</p>

Régler le jour de semaine à la première mise en service





<p>►Mo Tu We Th Fr Sa Su</p> <p>☀</p> <p>☾</p>	<p>Affichage : lundi au dimanche</p>
	<p>➔ Régler le jour de semaine à l'aide des touches de flèches.</p>
	<p>➔ Confirmer avec la touche OK.</p> <p>■ Le jour de semaine est réglé.</p>

Réglage de l'arrosage automatique







 <p>auto</p> <hr/> <p>►Mo ►Tu ►We ►Th ►Fr ►Sa ►Su</p> <p>☀ <input checked="" type="checkbox"/> <input type="checkbox"/> <input type="checkbox"/> <input type="checkbox"/> <input type="checkbox"/> <input type="checkbox"/> <input type="checkbox"/></p> <p>☾ <input type="checkbox"/> <input type="checkbox"/> <input type="checkbox"/> <input type="checkbox"/> <input type="checkbox"/> <input type="checkbox"/> <input type="checkbox"/></p> <p>🕒 00:00 🌿 100 min</p>	<p><i>L'affichage de l'arrosage clignote (activé)</i></p> <p>Remarque Le réglage d'usine pour l'heure et la durée d'arrosage sont le matin à 6h00, 5 minutes et le soir à 21h00, 5 minutes.</p>
	<p>Il est possible de naviguer dans le programme d'arrosage grâce aux touches de flèches.</p>
	<p>➔ Marquer avec la touche de confirmation Activation/Désactivation de l'arrosage</p> <p>Si l'heure et la durée pré-réglées sont correctes, d'autres périodes d'arrosage peuvent être sélectionnées avec les touches de flèches.</p> <p>Remarque Vous pouvez quitter le mode de réglage à tout moment avec la touche ESC/Menu.</p>



	<p>Si l'heure et la durée pré-réglées ne sont pas correctes :</p> <p>➔ confirmer avec la touche OK pour modifier l'heure et la durée de la période d'arrosage active.</p> <p><i>Les heures clignotent.</i></p>
	<p>➔ Régler les heures avec les flèches.</p>
	<p>➔ Confirmer avec la touche OK.</p> <p><i>Les minutes clignotent.</i></p>
	<p>➔ Régler les minutes avec les flèches.</p>
	<p>➔ Confirmer avec la touche OK.</p> <p><i>La durée d'arrosage clignote.</i></p>
	<p>➔ Régler les minutes avec les flèches.</p>
	<p>➔ Confirmer avec la touche OK.</p> <ul style="list-style-type: none"> ■ La durée d'arrosage est réglée. ■ Les autres périodes d'arrosage peuvent être maintenant réglées avec les touches de flèches.
	<p>➔ Quitter le mode de réglage avec la touche ESC/menu.</p> <p><i>L'arrosage automatique est activé.</i></p>
<p>Remarque Pour modifier ultérieurement les réglages, passer avec la touche ESC/menu et les touches de flèches en mode de réglage de l'arrosage automatique.</p>	

Réglage de l'arrosage automatique











	<p>→ Passer en mode de réglage avec la touche ESC/menu.</p>
	<p><i>Le symbole d'arrosage manuel clignote.</i></p>
	<p>→ Confirmer avec la touche OK.</p>
	<p><i>Le symbole d'arrosage apparaît.</i></p> <ul style="list-style-type: none"> ■ La vanne s'ouvre. ■ L'arrosage est actif.
	<p>→ La vanne se ferme avec la touche ESC/menu et une commutation se fait sur le mode automatique.</p> <p>→ La vanne se ferme avec la touche ok, une commutation se fait sur le mode de réglage et une nouvelle fonction peut être sélectionnée.</p>

Réglage de la fonction compte à rebours de l'arrosage

	<p>→ Passer en mode de réglage avec la touche ESC/menu.</p>
	<p>→ Sélectionner le mode d'arrosage avec les touches de flèches.</p>
	<p><i>Le symbole de la fonction compte à rebours clignote.</i></p>
	<p>→ Confirmer avec la touche OK.</p> <p><i>Les minutes clignotent.</i></p>
	<p>→ Régler les minutes avec les flèches.</p>
	<p>→ Confirmer avec la touche OK.</p>
	<p><i>Le symbole d'arrosage apparaît.</i></p> <ul style="list-style-type: none"> ■ La fonction de compte à rebours est activée. ■ La vanne s'ouvre. ■ L'arrosage est actif. <p><i>Après la fin du compte à rebours, la fonction passe en mode automatique.</i></p>

 	<p>Pour une fin anticipée :</p> <ul style="list-style-type: none"> → La vanne se ferme avec la touche ESC/ menu et une commutation se fait sur le mode automatique. → La vanne se ferme avec la touche ok, une commutation se fait sur le mode de réglage et une nouvelle fonction peut être sélectionnée.
---	--

Interruption de l'arrosage

	<ul style="list-style-type: none"> → Passer en mode de réglage avec la touche ESC/menu.
 	<ul style="list-style-type: none"> → Sélectionner le mode d'arrosage avec les touches de flèches.
   	<p><i>Le symbole d'interruption de l'arrosage clignote.</i></p>
	<ul style="list-style-type: none"> → Confirmer avec la touche OK. ■ Le réglage de l'arrosage est désactivé pour 24 heures.
 	<ul style="list-style-type: none"> → Pour une fin avant l'expiration des 24 heures, la fonction peut être interrompue avec la touche OK ou la touche ESC/ menu et une commutation en mode automatique se fait.

Fonctionnement

- Mettre l'unité de commande sur le bloc de vannes.
- Ouvrir le robinet d'eau.

Fin de l'utilisation

A la fin de la saison d'arrosage



- Fermer le robinet d'eau.
- Séparer l'arroseur automatique du robinet d'eau et du tuyau d'eau.
- L'unité de commande doit restée liée au bloc de vannes.
- Activer l'arrosage manuel afin que l'eau restante puisse s'écouler de l'arroseur automatique.
- Séparer l'unité de commande du bloc de vannes.
- Retirer la pile.
- Entreposer l'arroseur automatique dans un endroit sec et protégé du gel.

Entretien et maintenance

Nettoyer le joint de filtrage

- Retirer régulièrement le joint de filtrage dans le raccord d'eau et le rincer à l'eau courante.

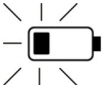
Batterie

	État de charge de la batterie complet
	État de charge de la batterie presque vide → Remplacer la batterie.
	État de charge de la batterie vide → Remplacer la batterie. Remarque En mode arrosage automatique, la vanne est fermée pour des raisons de sécurité. L'arrosage ne peut plus être activé.

changer la batterie

- Retirer l'unité de commande.
- Insérer une pile 9 V (type 6LR61) neuve.
Éliminer la batterie usée en respectant les dispositions en vigueur.
- Mettre l'unité de commande sur le bloc de vannes ; veiller au bon emplacement.

Remarque

L'ancienne batterie peut être remplacée par une neuve dans un délai de 3 minutes sans que les réglages d'arrosage et la programmation soient perdus.

Types de batterie utilisables :

- alcalines
- Batterie rechargeable à faible autodécharge et d'une capacité minimale de 250 mAh.

Remarque

Des batteries rechargeables ne tiennent pas une saison entière dans certaines circonstances.

Maintenance

L'appareil ne nécessite aucune maintenance.

Assistance en cas de panne

Panne	Cause	Élimination
L'arrosage n'a pas lieu en dépit de la programmation.	Robinet d'eau fermé.	Ouvrir le robinet d'eau.
	Pile vide.	Insérer une pile 9 V (type 6LR61) neuve.
	Contacts de raccordement de la pile oxydés.	Nettoyer les contacts.
	Joint de filtrage bouché.	Nettoyer le joint de filtrage.
La soupape ne s'ouvre / ne se ferme pas.	Lorsque l'unité de commande est retirée, la soupape ne peut pas s'ouvrir/se fermer.	Poser l'unité de commande sur le bloc de vannes.
Pas d'affichage à l'écran	Batterie vide ou contacts oxydés.	Mettre en place une batterie 9 V (type 6LR61) et nettoyer les contacts.
Fuite sur le raccord d'eau.	Joint de filtrage défectueux.	Remplacer le joint de filtrage.
	Le raccord d'eau s'est désolidarisé du robinet d'eau.	Resserrer le raccord d'eau.

Notre succursale Kärcher se tient à votre entière disposition pour d'éventuelles questions ou problèmes. L'adresse figure au dos.

Effectuer une réinitialisation

➔ Retirer la batterie du compartiment pour batteries jusqu'à ce que l'affichage soit entièrement éteint à l'écran.

ou

➔ Par une pression de 5 secondes sur la touche OK, les réglages sont réinitialisés.

Caractéristiques techniques

Pression de service	0,1 - 1,0 (1 - 10)	MPa (bars)
Température d'alimentation (max.)	35	°C
Température ambiante	+1 -> +60	°C
Type de pile	9V (6LR61 / alcaline)	
	9V (dimension comme : 6LR61 / Batterie rechargeable à faible autodécharge et d'une capacité minimale de 250 mAh)	

Sous réserve de modifications techniques.

Indice

Avvertenze generali	39
Norme di sicurezza	40
Uso	40
Cura e manutenzione	48
Guida alla risoluzione dei guasti	49
Dati tecnici	49

Avvertenze generali

Egregio cliente,



Prima di utilizzare l'apparecchio per la prima volta, leggere le presenti istruzioni originali, seguirle e conservarle per un uso futuro o in caso di rivendita dell'apparecchio.

Uso conforme a destinazione

- Questo apparecchio è concepito per il solo uso domestico e non deve essere adibito ad uso commerciale o industriale.
- Questo dispositivo è previsto per il collegamento ad un rubinetto e controlla automaticamente il flusso di acqua nei sistemi di irrigazione.

Protezione dell'ambiente



Tutti gli imballaggi sono riciclabili. Gli imballaggi non vanno gettati nei rifiuti domestici, ma consegnati ai relativi centri di raccolta.



Gli apparecchi dimessi contengono materiali riciclabili preziosi e vanno perciò consegnati ai relativi centri di raccolta. Si prega quindi di smaltire gli apparecchi dimessi mediante i sistemi di raccolta differenziata.

Avvertenze sulle componenti contenute (REACH)

Informazioni aggiornate sulle componenti contenute sono disponibili all'indirizzo: www.kaercher.de/REACH

Garanzia

Le condizioni di garanzia valgono nel rispettivo paese di pubblicazione da parte della nostra società di vendita competente. Entro il termine di garanzia eliminiamo gratuitamente eventuali guasti all'apparecchio, se causati da difetto di materiale o di produzione. Nei casi previsti dalla garanzia si prega di rivolgersi al proprio rivenditore, oppure al più vicino centro di assistenza autorizzato, esibendo lo scontrino di acquisto.

(Indirizzo vedi retro)

Simboli riportati nel manuale d'uso

PRUDENZA

Indica una probabile situazione pericolosa che può determinare danni leggeri a persone o danni alle cose.

Norme di sicurezza

PRUDENZA

- Non utilizzare l'automatismo di irrigazione nei sistemi di acqua potabile.
- Fare funzionare l'automatismo di irrigazione solo con acqua dolce chiara e non trattata con temperatura massima fino a 35 °C.
- Installare l'automatismo di irrigazione solo in ambienti esterni.
- Non esporre l'automatismo di irrigazione direttamente al getto d'acqua e non immergerlo mai nell'acqua.
- Prima di ogni utilizzo accertarsi che l'automatismo di irrigazione non sia danneggiato ed in caso di danni visibili interrompere il funzionamento.
- Applicare l'automatismo di irrigazione solo in posizione verticale.
- Non utilizzare alcun mastice ed alcun lubrificante per collegare l'automatismo di irrigazione al rubinetto.
- Non tirare dal tubo flessibile collegato.
- Utilizzare solo batterie da 9 V (tipo 6LR61).
- Non installare l'automatismo di irrigazione nei punti in cui si potrebbe formare della condensa poiché si potrebbe danneggiare la batteria.
- Non installare l'automatismo di irrigazione vicino a fonti di calore (temperatura ambiente massima 60 °C).
- Non utilizzare l'automatismo di irrigazione vicino a dispositivi sotto tensione.

Uso

Disimballare la confezione e controllare che il contenuto sia al completo e che non presenti danneggiamenti. Nel caso in cui si riscontrino danni informare immediatamente il proprio rivenditore.

Figure riportate sulla pagina pieghevole!



Descrizione dell'apparecchio

Per le figure vedi pagina 2

- 1 Riduttore (G $\frac{3}{4}$)
- 2 Raccordo dell'acqua (G 1) con guarnizione del filtro
- 3 Unità valvole
- 4 Giunto per tubo flessibile
- 5 Giunto per collegamento del tubo flessibile
- 6 Quadro di comando
- 7 Alloggiamento batterie
- 8 Display
- 9 Campo tasti

Descrizione display

Per le figure vedi pagina 3

- 1 Barra menù
- 2 Irrigazione automatica
- 3 Irrigazione manuale
- 4 Funzione di countdown dell'irrigazione
- 5 Interruzione dell'irrigazione
- 6 Stato batterie quadro di comando
- 7 Indicatore giorno settimanale
- 8 Indicatore programma d'irrigazione (attivato/disattivato)
- 9 Durata di irrigazione
- 10 Indicatore Irrigazione attivo
- 11 Tasto di conferma Attivazione/Disattivazione irrigazione
- 12 Menù Tasto ESC
- 13 Tasto OK
- 14 Tasti a freccia
- 15 Orario / Tempo di irrigazione
- 16 Indicatore Tempo d'irrigazione
- 17 Indicatore Tempo attuale
- 18 Periodo d'irrigazione (mattina/sera)

Funzione

All'apparecchio sono disponibili 4 modalità.

Irrigazione automatica

- Con questa funzione è possibile impostare individualmente i periodi d'irrigazione e l'irrigazione viene poi attivata e disattivata.

Irrigazione manuale

- Con questa funzione l'irrigazione viene manualmente inserita o disinserita.

Funzione di countdown dell'irrigazione

- Con questa funzione l'irrigazione viene automaticamente disinserita dopo un tempo desiderato (120 minuti al massimo).

Interruzione dell'irrigazione

- Con questa funzione l'irrigazione viene automaticamente interrotta per 24 ore.



Prima della messa in funzione

- ➔ Il rubinetto deve essere chiuso.
- ➔ Avvitare il giunto sull'attacco del tubo flessibile.
- ➔ All'occorrenza avvitare il riduttore sul raccordo dell'acqua.
- ➔ Tenere ferma l'unità valvole dal corpo e avvitare l'attacco dell'acqua sul rubinetto a sfera.





PRUDENZA

Mai collegare l'automatismo di irrigazione al rubinetto d'acqua senza la guarnizione del filtro in dotazione.

Preparazione unità di comando

	<p>Indicazione: La batteria non è in dotazione.</p> <p>➔ Mettere la batteria in posizione corretta (marcatura +/-) nel vano batteria.</p>
	<p>■ Non appena la batteria è inserita, la visualizzazione cambia, dopo un breve autotest, direttamente nella modalità di impostazione per l'orario attuale e il giorno settimanale. Le ore del display Orario lampeggiano.</p>

Impostazione dell'orario alla prima messa in funzione









	<p>Indicazione: L'ora lampeggia automaticamente, non appena è stata inserita la batteria.</p>
	<p>➔ Impostare le ore con i tasti a freccia.</p>
	<p>➔ Confermare con il tasto OK.</p> <p><i>1 minuti lampeggiano.</i></p>
	<p>➔ Impostare i minuti con i tasti a freccia.</p>
	<p>➔ Confermare con il tasto OK.</p> <p>■ L'ora è impostata.</p>

Impostazione del giorno settimanale alla prima messa in funzione





<p>►Mo Tu We Th Fr Sa Su</p> <p>☀</p> <p>☾</p>	<p>Display: Da lunedì a domenica</p>
<p>← →</p>	<p>→ Impostare il giorno settimanale con i tasti a freccia.</p>
<p>Ok</p>	<p>→ Confermare con il tasto OK.</p> <p>■ Il giorno settimanale è impostato.</p>

Impostazione dell'irrigazione automatica









<p> auto</p> <p>☀ ☾</p> <p>►Mo ►Tu ►We ►Th ►Fr ►Sa ►Su</p> <p>☀ ☾ ☐ ☐ ☐ ☐ ☐ ☐ ☐ ☐</p> <p>☐ ☐ ☐ ☐ ☐ ☐ ☐ ☐</p> <p>🕒 00:00 🕒 00 min</p>	<p><i>Il display irrigazione (attivato) lampeggia</i></p> <p>Indicazione</p> <p>Le impostazioni da stabilimento per il tempo e la durata d'irrigazione sono di mattina alle ore 6:00 di 5 minuti e la sera alle ore 21:00 di 5 minuti.</p>
<p>← →</p>	<p>Con i tasti a freccia è possibile navigare attraverso il programma d'irrigazione.</p>
<p>☑</p>	<p>→ Con il tasto di conferma Attivazione/Disattivazione marcare Irrigazione.</p> <p>Se l'orario e la durata pre-impostati sono a posto, con i tasti a freccia possono essere selezionati altri periodi d'irrigazione.</p> <p>Indicazione</p> <p>La modalità d'impostazione può essere abbandonata in qualsiasi momento con il tasto esc/menù.</p>

	<p>Se l'orario e la durata pre-impostati non sono a posto:</p> <p>➔ Confermare con il tasto OK per modificare l'orario e la durata del periodo d'irrigazione attivo.</p> <p><i>Le ore lampeggiano.</i></p>
	<p>➔ Impostare le ore con i tasti a freccia.</p>
	<p>➔ Confermare con il tasto OK.</p> <p><i>I minuti lampeggiano.</i></p>
	<p>➔ Impostare i minuti con i tasti a freccia.</p>
	<p>➔ Confermare con il tasto OK.</p> <p><i>La durata d'irrigazione lampeggia.</i></p>
	<p>➔ Impostare i minuti con i tasti a freccia.</p>
	<p>➔ Confermare con il tasto OK.</p> <ul style="list-style-type: none"> ■ La durata di irrigazione è impostata. ■ Quindi con i tasti a freccia è possibile impostare altri periodi d'irrigazione.
	<p>➔ Abbandonare la modalità di impostazione con il tasto esc/menù.</p> <p><i>L'irrigazione automatica è attivata.</i></p>
<p>Indicazione</p> <p>Per eseguire successivamente le modifiche delle impostazioni, cambiare nella modalità d'impostazione dell'irrigazione automatica con il tasto esc/menù e i tasti a freccia.</p>	





Impostazione dell'irrigazione manuale

	<p>→ Cambiare nella modalità di impostazione con il tasto esc/menù.</p>
	<p><i>Il simbolo per l'irrigazione manuale lampeggia.</i></p>
	<p>→ Confermare con il tasto OK.</p>
	<p><i>Appare il simbolo di irrigazione.</i></p> <ul style="list-style-type: none"> ■ La valvola si apre. ■ L'irrigazione è attiva.
	<p>→ Con il tasto esc/menù la valvola si chiude e si cambia nella modalità automatica.</p> <p>→ Con il tasto OK la valvola si chiude, viene cambiato nella modalità d'impostazione ed è possibile selezionare una nuova funzione.</p>

Impostazione della funzione di countdown dell'irrigazione

	<p>→ Cambiare nella modalità di impostazione con il tasto esc/menù.</p>
	<p>→ Selezionare la modalità d'irrigazione con i tasti a freccia.</p>
	<p><i>Il simbolo per la funzione di countdown lampeggia.</i></p>
	<p>→ Confermare con il tasto OK.</p> <p><i>I minuti lampeggiano.</i></p>
	<p>→ Impostare i minuti con i tasti a freccia.</p>
	<p>→ Confermare con il tasto OK.</p>
	<p><i>Appare il simbolo di irrigazione.</i></p> <ul style="list-style-type: none"> ■ La funzione di countdown è attivata. ■ La valvola si apre. ■ L'irrigazione è attiva. <p><i>Scaduto il tempo del countdown, la funzione cambia nella modalità automatica.</i></p>
	<p>Per terminare anticipatamente la funzione:</p> <p>→ Con il tasto esc/menù la valvola si chiude e si cambia nella modalità automatica.</p> <p>→ Con il tasto OK la valvola si chiude, viene cambiato nella modalità d'impostazione ed è possibile selezionare una nuova funzione.</p>

Interruzione dell'irrigazione

	→ Cambiare nella modalità di impostazione con il tasto esc/menù .
	→ Selezionare la modalità d'irrigazione con i tasti a freccia.
	<i>Il simbolo per l'interruzione dell'irrigazione lampeggia.</i>
	→ Confermare con il tasto OK . ■ L'impostazione per l'irrigazione è disattivata per 24 ore.
	→ Per terminare la funzione prima che scada il timer di 24 ore con il tasto OK o il tasto esc/menù è possibile interrompere la funzione e si cambia nella modalità automatica.

Funzionamento

- Mettere l'unità di comando sopra l'unità valvole.
- Aprire il rubinetto d'acqua.

Dopo l'uso

Alla fine della stagione dell'irrigazione



- Chiudere il rubinetto.
- Scollegare l'automatismo di irrigazione dal rubinetto e dal tubo flessibile dell'acqua.
- L'unità di comando deve rimanere collegata all'unità valvole.
- Attivare l'irrigazione manuale affinché l'acqua residua possa defluire dall'automatismo di irrigazione.
- Staccare l'unità di comando dall'unità valvole.
- Rimuovere la batteria.
- Riporre l'automatismo di irrigazione in un luogo asciutto e protetto dal gelo.

Cura e manutenzione

Pulizia della guarnizione del filtro

- ➔ Rimuovere regolarmente la guarnizione del filtro nel raccordo dell'acqua e sciacquare il filtro sotto acqua corrente.

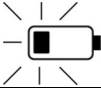
Batteria

	Stato batteria piena
	Stato batteria quasi scarica ➔ Rinnovare la batteria.
	Stato batteria scarica ➔ Rinnovare la batteria. Indicazione In modalità automatica d'irrigazione, la valvola per sicurezza viene chiusa. L'irrigazione non può essere più attivata.

Sostituire la batteria.

- ➔ Togliere l'unità di comando.
- ➔ Inserire una nuova batteria da 9 V (tipo 6LR61).
Smaltire la batteria scarica in conformità alle disposizioni in vigore.
- ➔ Mettere l'unità di comando sull'unità valvole, fare attenzione alla sua sede corretta.

Indicazione

La vecchia batteria può essere sostituita da una nuova entro 3 minuti, senza che le impostazioni dell'irrigazione e la programmazione vengano perse.

Tipi di batteria utilizzabili:

- Alcaline
- Batteria ricaricabile con scarica minima possibile e con una capacità minima di 250 mAh.

Indicazione

In alcune circostanze, le batterie ricaricabili non tengono una stagione completa.

Manutenzione

L'apparecchio è senza manutenzione.

Guida alla risoluzione dei guasti

Guasto	Causa	Rimedio
Nonostante la programmazione non ha luogo alcuna irrigazione.	Rubinetto chiuso.	Aprire il rubinetto.
	Batteria scarica.	Inserire una nuova batteria da 9 V (tipo 6LR61).
	Contatti di collegamento delle batterie ossidati.	Pulire i contatti.
	Guarnizione del filtro otturato.	Pulire la guarnizione del filtro.
Valvola non apre / non chiude.	Con elemento di comando la valvola non può aprire / chiudere.	Collocare l'unità di comando all'unità valvole.
Nessuna visualizzazione a display	Batteria scarica o contatti ossidati.	Inserire una nuova batteria da 9V (tipo 6LR61) oppure pulire i contatti.
Perdita dal raccordo dell'acqua.	Guarnizione del filtro difettosa.	Sostituire la guarnizione del filtro.
	Il raccordo dell'acqua si è staccato dal rubinetto.	Avvitare nuovamente il raccordo dell'acqua.

In caso di domande o anomalie la filiale Kärcher è felice di poterla aiutare. Indirizzo vedi retro.

Esecuzione di un reset

➔ Rimuove la batteria dal vano batteria finché la visualizzazione sul display è completamente sparita.

oppure

➔ Premendo per 5 secondi il tasto OK le impostazioni vengono resettate.

Dati tecnici

Pressione di esercizio	0,1 - 1,0 (1 - 10)	MPa (bar)
Temperatura in entrata (max.)	35	°C
Temperatura ambiente	+1 -> +60	°C
Tipo batteria	9V (6LR61 / alcaline)	
	9V (grandezza costruttiva come: 6LR61 /Batteria ricaricabile con scarica minima possibile e con una capacità minima di 250 mAh)	

Con riserva di modifiche tecniche.

Inhoud

Algemene instructies	50
Veiligheidsinstructies	51
Bediening	51
Onderhoud	59
Hulp bij storingen	60
Technische gegevens	60

Algemene instructies

Geachte klant,



Lees vóór het eerste gebruik van uw apparaat deze originele gebruiksaanwijzing, ga navenant te werk en bewaar deze voor later gebruik of voor een latere eigenaar.

Doelmatig gebruik

- Dit apparaat is voor privé-gebruik ontwikkeld en is niet bedoeld voor industrieel gebruik.
- Dit apparaat is voorzien voor de aansluiting aan een waterkraan en regelt automatisch de waterstroming in besproeiingssystemen.

Zorg voor het milieu



Het verpakkingsmateriaal is herbruikbaar. Deponeer het verpakkingsmateriaal niet bij het huishoudelijk afval, maar bied het aan voor hergebruik.



Onbruikbaar geworden apparaten bevatten waardevolle materialen die geschikt zijn voor hergebruik. Lever de apparaten daarom in bij een inzamel-punt voor herbruikbare materialen.

Informatie over stoffen (REACH)

Actuele informatie over stoffen vindt u onder:

www.kaercher.de/REACH

Garantie

In ieder land zijn de door ons bevoegde verkoopkantoor uitgegeven garantiebepalingen van toepassing. Eventuele storingen aan het apparaat verhelpen wij zonder kosten binnen de garantietermijn, mits een materiaal of fabrieksfout de oorzaak van deze storing is. Neem bij klachten binnen de garantietermijn contact op met uw leverancier of de dichtstbijzijnde klantenservicewerkplaats en neem uw aankoopbewijs mee.

(adres zie achterzijde)

Symbolen in de gebruiksaanwijzing

VOORZICHTIG

Voor een mogelijke gevaarlijke situatie die tot lichte verwondingen of materiële schade kan leiden.

Veiligheidsinstructies

VOORZICHTIG

- *Besproeiingsautomaat niet in drinkwatersystemen gebruiken.*
- *Besproeiingsautomaat enkel met onbehandeld, zuiver zoet water met een temperatuur tot max. 35°C gebruiken.*
- *Besproeiingsautomaat enkel buiten installeren.*
- *Besproeiingsautomaat niet blootstellen aan een directe waterstraal en nooit in water dompelen.*
- *Besproeiingsautomaat voor elk gebruik op schade controleren, bij zichtbare beschadigingen gebruik stopzetten.*
- *Besproeiingsautomaat enkel verticaal aanbrengen.*
- *Geen pakkingmateriaal en geen smeermiddelen gebruiken om de besproeiingsautomaat aan de waterkraan aan te sluiten.*
- *Niet aan de aangesloten slang trekken.*
- *Enkel 9V-batterijen (type 6LR61) gebruiken.*
- *Besproeiingsautomaat niet installeren op plaatsen waar condensatiewater wordt gevormd, aangezien daardoor de batterij beschadigd kan worden.*
- *Besproeiingsautomaat niet in de buurt van warmtebronnen installeren (maximale omgevingstemperatuur 60°C).*
- *Besproeiingsautomaat niet in de buurt van onder spanning staande apparatuur gebruiken.*

Bediening

Controleer bij het uitpakken de inhoud van de verpakking op volledigheid en beschadigingen. Neem ingeval van opmerkingen contact op met uw dealer.

Afbeeldingen zie uitklapbaar blad!



Beschrijving apparaat

Afbeeldingen zie pagina 2

- 1 Verloopstuk (G $\frac{3}{4}$)
- 2 Wateraansluiting (G 1) met filterafdichting
- 3 Klepeenheid
- 4 Slangaansluiting
- 5 Koppelgedeelte voor slang aansluiting
- 6 Bedieningseenheid
- 7 Batterijvak
- 8 Display
- 9 Toetsenveld

Displaybeschrijving

Afbeeldingen zie pagina 3

- 1 Menulijst
- 2 Automatische besproeiing
- 3 Manuele bewatering
- 4 Countdown-functie besproeiing
- 5 Onderbreking besproeiing
- 6 Batterijstatus bedieningseenheid
- 7 Weergave weekdag
- 8 Weergave besproeiingsprogramma (geactiveerd/gedeactiveerd)
- 9 Besproeiingsduur
- 10 Weergave besproeiing is actief
- 11 Bevestigingstoets activering/deactivering besproeiing
- 12 menu / esc-toets
- 13 ok-toets
- 14 Pijltoetsen
- 15 Uur / besproeiingstijd
- 16 Weergave besproeiingstijd
- 17 Weergave actuele tijd
- 18 Besproeiingsperiode ('s morgens/'s avonds)

Functie

Op het apparaat staan 4 modi ter beschikking.

Automatische besproeiing

- Met die functie kunnen besproeiingsperiodes individueel ingesteld worden en de besproeiing wordt automatisch geactiveerd en gedeactiveerd.

Manuele bewatering

- Met die functie wordt de besproeiing manueel in- of uitgeschakeld.

Countdown-functie besproeiing

- Met die functie wordt de besproeiing na een gewenste tijd (max. 120 minuten) automatisch uitgeschakeld.

Onderbreking van de besproeiing

- Met die functie wordt de automatische besproeiing 24 uren uitgezet.

Voor ingebruikneming

- Waterkraan moet gesloten zijn.
- Koppelgedeelte op slangaansluiting schroeven.
- Indien nodig het verloopstuk op de wateraansluiting draaien.
- Klepeenheid aan de behuizing houden en wateraansluiting op de waterkraan schroeven.



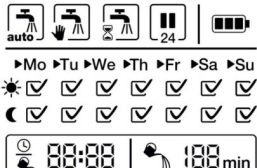

VOORZICHTIG

Besproeiingsautomaat nooit zonder meegeleverde filterafdichting op de waterkraan aansluiten.

Vorbereiding bedieningseenheid

	<p>Instructie: De batterij wordt niet meegeleverd.</p> <p>➔ Batterij in de juiste positie (+/- markering) in het batterijvak leggen.</p>
	<p>■ Zodra de batterij is ingelegd, springt de weergave na een korte zelftest direct in de instelmodus voor het huidige uur en weekdag. De uren van de weergave Uur knippen.</p>





Uur instellen bij de eerste inbedrijfstelling









	<p>Instructie: Zodra de batterij werd ingelegd, knippert het uur automatisch.</p>
	<p>➔ Stel de uren in met de pijltoetsen.</p>
	<p>➔ Bevestig met de ok-toets.</p> <p><i>De minuten knippen.</i></p>
	<p>➔ Stel de minuten in met de pijltoetsen.</p>
	<p>➔ Bevestig met de ok-toets.</p> <p>■ Het uur is ingesteld.</p>

Weekdag instellen bij de eerste inbedrijfstelling





<p>►Mo Tu We Th Fr Sa Su</p> <p>☀</p> <p>☾</p>	<p>Weergave: maandag tot zondag</p>
<p>← →</p>	<p>→ Stel de weekdag in met de pijltoetsen.</p>
<p>Ok</p>	<p>→ Bevestig met de ok-toets.</p> <p>■ De weekdag is ingesteld.</p>

Instelling automatische besproeiing









<p> auto </p> <p>►Mo ►Tu ►We ►Th ►Fr ►Sa ►Su</p> <p>☀ <input checked="" type="checkbox"/> <input type="checkbox"/> <input type="checkbox"/> <input type="checkbox"/> <input type="checkbox"/> <input type="checkbox"/> <input type="checkbox"/></p> <p>☾ <input type="checkbox"/> <input type="checkbox"/> <input type="checkbox"/> <input type="checkbox"/> <input type="checkbox"/> <input type="checkbox"/> <input type="checkbox"/></p> <p> 00:00  00 min</p>	<p><i>De weergave Besproeiing knippert (geactiveerd)</i></p> <p>Tip De fabrieksinstelling voor de besproeiingstijd en -duur is 's morgens 6:00, 5 minuten en 's avonds 21:00, 5 minuten.</p>
<p>← →</p>	<p>Met de pijltoetsen kan door het besproeiingsprogramma genavigeerd worden.</p>
<p><input checked="" type="checkbox"/></p>	<p>→ Markeer de besproeiing met de bevestigingstoets activering/deactivering.</p> <p>Als de vooringestelde tijd en duur in orde zijn, kunnen met de pijltoetsen andere besproeiingsperiodes geselecteerd worden.</p> <p>Tip Met de esc/menu-toets kan de instelmodus altijd verlaten worden.</p>

	<p>Als de vooringestelde tijd en duur niet in orde zijn:</p> <p>➔ met ok-toets bevestigen om de tijd en duur van de actieve besproeiingsperiode te veranderen.</p> <p><i>De uren knipperen.</i></p>
	<p>➔ Stel de uren in met de pijltoetsen.</p>
	<p>➔ Bevestig met de ok-toets.</p> <p><i>De minuten knipperen.</i></p>
	<p>➔ Stel de minuten in met de pijltoetsen.</p>
	<p>➔ Bevestig met de ok-toets.</p> <p><i>De besproeiingsduur knippert.</i></p>
	<p>➔ Stel de minuten in met de pijltoetsen.</p>
	<p>➔ Bevestig met de ok-toets.</p> <ul style="list-style-type: none"> ■ De besproeiingsduur is ingesteld. ■ Er kunnen nu andere besproeiingsperiodes met de pijltoetsen ingesteld worden.
	<p>➔ Verlaat de instelmodus met de esc/ menu-toets.</p> <p><i>Automatische besproeiing is geactiveerd.</i></p>
<p>Tip Om achteraf de instellingen te veranderen, schakelt u met de esc/menu-toets en de pijltoetsen over naar de instelmodus voor de automatische besproeiing.</p>	





Instelling manuele besproeiing

	<p>→ Ga met de esc/menu-toets naar de instelmodus.</p>
	<p><i>Het symbool voor de manuele besproeiing knippert.</i></p>
	<p>→ Bevestig met de ok-toets.</p>
	<p><i>Het besproeiingssymbool verschijnt.</i></p> <ul style="list-style-type: none"> ■ Vervolgens gaat de klep open. ■ De besproeiing is actief.
	<p>→ Met de esc/menu-toets gaat de klep dicht en wordt overgeschakeld op de automatische modus.</p> <p>→ Met de ok-toets gaat de klep dicht, er wordt naar de instelmodus omgeschakeld en er kan een nieuwe functie geselecteerd worden.</p>

Instelling countdown-functie besproeiing

	<p>→ Ga met de esc/menu-toets naar de instelmodus.</p>
	<p>→ Selecteer de besproeiingsmodus met de pijltoetsen.</p>
	<p><i>Het symbol voor de countdown-functie knippert.</i></p>
	<p>→ Bevestig met de ok-toets.</p> <p><i>De minuten knipperen.</i></p>
	<p>→ Stel de minuten in met de pijltoetsen.</p>
	<p>→ Bevestig met de ok-toets.</p>
	<p><i>Het besproeiingssymbool verschijnt.</i></p> <ul style="list-style-type: none"> ■ De countdown-functie is geactiveerd. ■ Vervolgens gaat de klep open. ■ De besproeiing is actief. <p><i>Na afloop van de countdown gaat de functie over op de automatische modus.</i></p>
	<p>Voor vroegtijdige beëindiging:</p> <p>→ Met de esc/menu-toets gaat de klep dicht en wordt overgeschakeld op de automatische modus.</p> <p>→ Met de ok-toets gaat de klep dicht, er wordt naar de instelmodus omgeschakeld en er kan een nieuwe functie geselecteerd worden.</p>

Onderbreking besproeiing

	→ Ga met de esc/menu-toets naar de instelmodus.
	→ Selecteer de besproeiingsmodus met de pijltoetsen.
	<i>Het symbol voor de onderbreking van de besproeiing knippert.</i>
	→ Bevestig met de ok-toets . ■ De besproeiingsinstelling is voor 24 uren gedeactiveerd.
	→ Om voor afloop van de 24 uren te beëindigen, kan de functie met de ok-toets of esc/menu-toets onderbroken worden en wordt in de automatische modus omgeschakeld.

Gebruik

- Zet de bedieningseenheid op klepeenheid.
- Waterkraan opendraaien.

De werkzaamheden beëindigen

Op het einde van het bewateringsseizoen



- Waterkraan dichtdraaien.
- Bewateringsautomaat van waterkraan en waterslang halen.
- De bedieningseenheid moet met de klepeenheid verbonden blijven.
- Manuele bewatering activeren, opdat restwater uit de bewateringsautomaat kan stromen.
- Scheid de bedieningseenheid van de klepeenheid.
- Batterij verwijderen.
- Bewateringsautomaat op een droge en vorstvrije plaats opslaan.

Onderhoud

Filterafdichting reinigen

- Filterpakking geregeld uit de wateraansluiting nemen en onder stromend water uitspoelen.

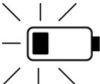
Accu

	Batterijstatus vol
	Batterijstatus bijna leeg → Vervang de batterij.
	Batterijstatus leeg → Vervang de batterij. Tip In de modus automatische besproeiing wordt de klep voor de veiligheid gesloten. De besproeiing kan niet meer geactiveerd worden.

Batterij vervangen

- Neem de bedieningseenheid weg.
- Leg een nieuwe 9V-batterij (type 6LR61) in.
Verbruikte batterij conform de geldende bepalingen verwijderen.
- Zet de bedieningseenheid op klepeenheid, let op een correcte positionering.

Tip

De oude batterij kan binnen 3 minuten door een nieuwe vervangen worden, zonder dat de besproeiingsinstellingen en programmering verloren gaan.

Bruikbare batterijtypes:

- alkaline
- heroplaadbare batterijen met een lage zelfontlading en met een capaciteit van minimum 250 mAh.

Tip

Heroplaadbare batterijen gaan mogelijk niet een volledig seizoen mee.

Onderhoud

Het apparaat is onderhoudsvrij.

Hulp bij storingen

Storing	Oorzaak	Oplossing
Bewatering vindt niet plaats ondanks programmering.	Waterkraan dicht.	Waterkraan openen.
	Batterij leeg.	Leg een nieuwe 9V-batterij (type 6LR61) in.
	Batterijaansluitcontacten geoxideerd.	Contacten reinigen.
	Filterpakking verstopt.	Filterpakking reinigen
Klep gaat niet open/dicht.	Bij een afgenomen bedieningseenheid kan de klep niet openen/sluiten.	Breng de bedieningseenheid op de klepeenheid aan.
Geen display-weergave	Batterij leeg of contacten geoxideerd.	Leg een nieuwe 9V batterij (type 6LR61) in of reinig de contacten.
Lekkage aan de wateraansluiting.	Filterpakking defect.	Filterpakking vervangen.
	Wateraansluiting aan de waterkraan is losgekomen.	Wateraansluiting weer vastschroeven.

Bij vragen of storingen helpt onze Kärcher-vestiging u graag verder. Adres zie achterzijde.

Reset uitvoeren

→ Neem de batterij uit de batterijhouder, tot de weergave op het display volledig gedoofd is.

of

→ Door de ok-toets 5 seconden in te drukken, wordt de instelling gereset.

Technische gegevens

Bedrijfsdruk	0,1 - 1,0 (1 - 10)	MPa (bar)
Toevoertemperatuur (max.)	35	°C
Omgevingstemperatuur	+1 -> +60	°C
Batterijtype	9V (6LR61 / alkaline)	
	9V (bouwmaat zoals: 6LR61 / heroplaadbare batterij met een lage zelfontlading en met een capaciteit van minimum 250 mAh).	

Technische wijzigingen voorbehouden.

Índice de contenidos

Indicaciones generales	61
Indicaciones de seguridad	62
Manejo	62
Cuidados y mantenimiento	70
Ayuda en caso de avería	71
Datos técnicos	71

Indicaciones generales

Estimado cliente:



Antes del primer uso de su aparato, lea este manual original, actúe de acuerdo a sus indicaciones y guárdelo para un uso posterior o para otro propietario posterior.

Uso previsto

- Este aparato ha sido diseñado para el uso particular y no para los esfuerzos del uso industrial.
- Este aparato está diseñado para su conexión a un grifo de agua y regula automáticamente el caudal en los sistemas de riego.

Protección del medio ambiente



Los materiales de embalaje son reciclables. Por favor, no tire el embalaje a la basura doméstica; en vez de ello, entréguelo en los puntos oficiales de recogida para su reciclaje o recuperación.



Los aparatos viejos contienen materiales valiosos reciclables que deberían ser entregados para su aprovechamiento posterior. Por este motivo, entregue los aparatos usados en los puntos de recogida previstos para su reciclaje.

Aviso sobre sustancias (REACH)

Encontrará información actual sobre las sustancias en:

www.kaercher.de/REACH

Garantía

En todos los países rigen las condiciones de garantía establecidas por nuestra empresa distribuidora. Las averías del aparato serán subsanadas gratuitamente dentro del periodo de garantía, siempre que se deban a defectos de material o de fabricación. En un caso de garantía, le rogamos que se dirija con el comprobante de compra al distribuidor donde adquirió el aparato o al servicio al cliente autorizado más próximo a su domicilio.

(La dirección figura al dorso)

Símbolos del manual de instrucciones

PRECAUCIÓN

Para una situación que puede ser peligrosa, que puede acarrear lesiones leves o daños materiales.

Indicaciones de seguridad

PRECAUCIÓN

- No utilizar los equipos automáticos de riego en sistemas de agua potable.
- Utilizar los equipos automáticos de riego solamente con agua dulce, no tratada, con una temperatura máxima de 35°C.
- Instalar el equipo automático de riego solamente en exterior.
- No someter el sistema automático de riego directamente al chorro de agua y no sumergirlo nunca en agua.
- Comprobar antes de cada utilización si el equipo automático de riego está dañado, si hay daños visibles debe dejar de usarlo.
- Colocar el equipo automático de riego solamente en posición vertical.
- No usar masa para juntas ni lubricante para conectar el equipo automático de riego al grifo de agua.
- No tirar de la manguera conectada.
- Usar únicamente pilas de 9V (tipo 6LR61).
- No instalar el equipo automático de riego en lugares donde se forma agua de condensación, pues esta puede dañar la pila.
- No instalar el equipo automático de riego cerca de fuentes de calor (temperatura ambiente máxima 60°C).
- No utilizar el equipo automático de riego cerca de aparatos sometidos a tensión.

Manejo

Verifique durante el desembalaje que no falte ninguna pieza ni haya daños. Si debe hacer alguna reclamación, informe a su distribuidor.

Ilustraciones, véase la contraportada.



Descripción del aparato

Ilustraciones, véase la página 2

- 1 Pieza reductora (G $\frac{3}{4}$)
- 2 toma de agua (G 1) con junta del filtro
- 3 Unidad de la válvula
- 4 empalme de manguera
- 5 Pieza de acoplamiento para conexión de manguera
- 6 Unidad de operación
- 7 Compartimento de las pilas
- 8 anuncio
- 9 Teclado

Descripción de pantalla

Ilustraciones, véase la página 3

- 1 Barra de tareas
- 2 Riego automático
- 3 Riego manual
- 4 Riego con función de cuenta atrás
- 5 Interrupción del riego
- 6 Estado de batería de la unidad de mando
- 7 Visualización del día de la semana
- 8 Visualización programa de riego (activado/desactivado)
- 9 Duración de riego
- 10 Visualización riego activa
- 11 Tecla de confirmación activación/desactivación riego
- 12 menú / tecla esc
- 13 Tecla ok
- 14 Teclas de flechas
- 15 Hora / horario de riego
- 16 Visualización tiempo de riego
- 17 Visualización tiempo actual
- 18 Período de riego (mañana/noche)

Función

El equipo dispone de 4 modos de funcionamiento.

Riego automático

- Con esta función se pueden configurar individualmente los períodos de riego y el riego se activa y desactiva automáticamente.

Riego manual

- Con esta función se puede conectar y desconectar el riego manualmente.

Riego con función de cuenta atrás

- Con esta función se puede desconectar automáticamente el riego tras el período de tiempo deseado (máx. 120 minutos).

Interrupción del riego

- Con esta función se puede interrumpir durante 24 horas el riego automático.



Antes de la puesta en marcha

- ➔ El grifo de agua tiene que estar cerrada.
- ➔ Atornillar la pieza de acoplamiento a la conexión de manguera.
- ➔ Si es necesario, atornillar la pieza reductora a la toma de agua.
- ➔ Sujetar la unidad de válvula a la carcasa y atornillar la conexión de agua al grifo.





PRECAUCIÓN

No conectar nunca el equipo automático de riego al grifo de agua sin la junta de filtro suministrada.

Preparación unidad de operación

	<p>Nota: La batería no viene incluida.</p> <p>➔ Colocar la batería correctamente (marcas +/-) en el compartimento de baterías.</p>
	<p>■ Tan pronto como la batería está colocada, la pantalla cambia directamente al modo de configuración para la hora actual y el día de la semana. Las horas de la indicación de las horas parpadean.</p>





Configurar la hora en la puesta en marcha









	<p>Indicación: Tan pronto como se coloca la batería, la hora parpadea automáticamente.</p>
	<p>➔ Configurar las horas con las flechas.</p>
	<p>➔ Confirmar con la tecla ok.</p> <p><i>Parpadean los minutos.</i></p>
	<p>➔ Configurar los minutos con las flechas.</p>
	<p>➔ Confirmar con la tecla ok.</p> <p>■ La hora está ajustada.</p>

Configurar el día de la semana en la puesta en marcha





<p>►Mo Tu We Th Fr Sa Su</p> <p>☀ ☾</p>	<p>Indicación: Lunes a domingo</p>
<p>← →</p>	<p>→ Configurar el día de la semana con las flechas.</p>
<p>Ok</p>	<p>→ Confirmar con la tecla ok.</p> <p>■ El día de la semana está configurado.</p>

Configuración riego automático







<p> auto </p> <p>►Mo ►Tu ►We ►Th ►Fr ►Sa ►Su</p> <p>☀ <input checked="" type="checkbox"/> <input type="checkbox"/> <input type="checkbox"/> <input type="checkbox"/> <input type="checkbox"/> <input type="checkbox"/> <input type="checkbox"/></p> <p>☾ <input type="checkbox"/> <input type="checkbox"/> <input type="checkbox"/> <input type="checkbox"/> <input type="checkbox"/> <input type="checkbox"/> <input type="checkbox"/></p> <p> 00:00  00 min</p>	<p><i>Parpadea el piloto del riego (activado)</i></p> <p>Nota La configuración de fábrica para el período y dirección de riego es 5 minutos a las 6:00 de la mañana y de 5 minutos a las 21:00 de la noche.</p>
<p>← →</p>	<p>Con las flechas se puede navegar por el programa de riego.</p>
<p><input checked="" type="checkbox"/></p>	<p>→ Marcar la activación/desactivación de riego con la tecla de confirmación.</p> <p>Si la hora y la duración preconfiguradas son correctas, se pueden seleccionar otros períodos de riego.</p> <p>Nota Con la tecla esc/menú se puede salir en todo momento del modo de configuración.</p>

	<p>Si la hora y la duración preconfiguradas no son correctas:</p> <p>➔ Confirmar con la tecla ok, para modificar la hora y la duración del período de riego activo.</p> <p><i>Parpadean las horas.</i></p>
	<p>➔ Configurar las horas con las flechas.</p>
	<p>➔ Confirmar con la tecla ok.</p> <p><i>Parpadean los minutos.</i></p>
	<p>➔ Configurar los minutos con las flechas.</p>
	<p>➔ Confirmar con la tecla ok.</p> <p><i>Parpadea la duración de riego.</i></p>
	<p>➔ Configurar los minutos con las flechas.</p>
	<p>➔ Confirmar con la tecla ok.</p> <ul style="list-style-type: none"> ■ Se ha configurado la duración de riego. ■ Ahora se pueden configurar otros períodos de riego con las flechas.
	<p>➔ Salir del modo de configuración con la tecla esc/menú.</p> <p><i>El riego automático está activado.</i></p>
<p>Nota Para modificar posteriormente las configuraciones, cambiar al modo de configuración del riego automático con la tecla esc/menú y las flechas.</p>	





Configuración riego manual

	<p>→ Cambiar al modo de configuración con la tecla esc/menú.</p>
	<p><i>El símbolo de riego manual parpadea.</i></p>
	<p>→ Confirmar con la tecla ok.</p>
	<p><i>Aparece el símbolo de riego.</i></p> <ul style="list-style-type: none"> ■ Se abre la válvula. ■ El riego está activado.
	<p>→ Con la tecla esc/menú se cierra la válvula y se cambia automáticamente al modo automático.</p> <p>→ Con la tecla ok se cierra la válvula, se cambia al modo de configuración y se puede seleccionar una nueva función.</p>

Configuración riego con función de cuenta atrás

	<p>→ Cambiar al modo de configuración con la tecla esc/menú.</p>
	<p>→ Seleccionar el modo de riego con las flechas.</p>
	<p><i>El símbolo de la función de cuenta atrás parpadea.</i></p>
	<p>→ Confirmar con la tecla ok.</p> <p><i>Parpadean los minutos.</i></p>
	<p>→ Configurar los minutos con las flechas.</p>
	<p>→ Confirmar con la tecla ok.</p>
	<p><i>Aparece el símbolo de riego.</i></p> <ul style="list-style-type: none"> ■ La función de cuenta atrás está activada. ■ Se abre la válvula. ■ El riego está activado. <p><i>Tras finalizar la cuenta atrás, la función cambia al modo automático.</i></p>
	<p>Para finalizar prematuramente:</p> <p>→ Con la tecla esc/menú se cierra la válvula y se cambia automáticamente al modo automático.</p> <p>→ Con la tecla ok se cierra la válvula, se cambia al modo de configuración y se puede seleccionar una nueva función.</p>

Interrupción del riego

	→ Cambiar al modo de configuración con la tecla esc/menú .
	→ Seleccionar el modo de riego con las flechas.
	<i>El símbolo de interrupción del riego parpadea.</i>
	→ Confirmar con la tecla ok . ■ Se ha desactivado la configuración de riego durante 24 horas.
	→ Para finalizar antes de que se acaben las 24 horas, se puede pulsar la tecla ok o la tecla esc/menú para interrumpir la función y se cambia al modo automático.

Funcionamiento

- Colocar la unidad de mando en la unidad de válvula.
- Abrir el grifo del agua.

Finalización del funcionamiento

Al final de la temporada de riego



- Cerrar el grifo del agua.
- Desconectar el equipo automático de riego del grifo del agua y de la manguera de agua.
- La unidad de mando tiene que estar unida a la unidad de válvula.
- Activar riego manual, para que salga el agua residual del equipo automático de riego.
- Separar la unidad de mando de la unidad de válvula.
- Retirar la pila.
- Guardar el equipo automático de riego en un lugar seco y protegido de las heladas.

Cuidados y mantenimiento

Limpiar la junta de filtro

- Sacar regularmente la junta de filtro de la conexión de agua y enjuagarla bajo agua corriente.

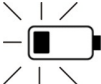
Batería

	Estado de batería lleno
	Estado de la batería casi vacío → Cambiar la batería.
	Estado de la batería vacío → Cambiar la batería. Nota En modo de riego automático se cierra la válvula por seguridad. No se puede volver a activar el riego.

Cambiar la batería

- Extraer la unidad de mando.
- Colocar pila nueva de 9V (tipo 6LR61).
Eliminar la batería usada de acuerdo con las normativas vigentes.
- Colocar la unidad de mando en la unidad de válvula, respetar la posición correcta.

Nota

La batería vieja, se puede sustituir en 3 minutos por una nueva sin que se pierdan las configuraciones de riego y programación.

Tipos de batería que se pueden utilizar:

- Alcalina
- Batería recargable con autodescarga y con una capacidad de al menos 250 mAh.

Nota

Las baterías recargables no aguantan una temporada completa bajo ningún concepto.

Mantenimiento

El aparato no precisa mantenimiento.

Ayuda en caso de avería

Avería	Causa	Solución
A pesar de estar programado, no se ejecuta el riego.	Grifo de agua cerrado.	Abrir el grifo del agua.
	Pila agotada.	Colocar pila nueva de 9V (tipo 6LR61).
	Contactos de conexión de la pila oxidados.	Limpiar los contactos.
	Junta de filtro obstruida.	Limpiar la junta de filtro.
Válvula no abre/cierra.	Con la unidad de mando extraída, la válvula no se puede abrir/cerrar.	Colocar la unidad de mando en la unidad de válvula.
Sin indicador de pantalla	Batería vacía o contactos oxidados.	Colocar una pila nueva de 9V (tipo 6LR61) o limpiar los contactos.
Fuga en la conexión de agua.	Junta de filtro averiada.	Sustituir junta de filtro.
	La conexión de agua en el grifo de agua se ha soltado.	Volver a enroscar la conexión de agua.

En caso de dudas o alteraciones, la sucursal de Kärcher estará encantada de ayudarle. La dirección figura al dorso.

Resetear

→ Sacar la batería del compartimento hasta que se apague totalmente el indicador de la pantalla.

o
→ Si se pulsa la tecla ok durante 5 segundos, se restablece la configuración.

Datos técnicos

Presión de trabajo	0,1 - 1,0 (1 - 10)	MPa (bar)
Temperatura de entrada (máx.)	35	°C
Temperatura ambiente	+1 -> +60	°C
Tipo de batería	9V (6LR61 / alcalina) 9V (tamaño como: 6LR61 / batería recargable con autodescarga y con una capacidad de al menos 250 mAh)	

Sujeto a modificaciones técnicas.

Índice

Instruções gerais	72
Avisos de segurança	73
Manuseamento.	73
Conservação e manutenção.	81
Ajuda em caso de avarias	82
Dados técnicos.	82

Instruções gerais

Estimado cliente,



Leia o manual de manual original antes de utilizar o seu aparelho. Proceda conforme as indicações no manual e guarde o manual para uma consulta posterior ou para terceiros a quem possa vir a vender o

aparelho.

Utilização conforme as disposições

- Este aparelho foi desenvolvido para o uso privado e não foi concebido para suster as necessidades de uma utilização industrial.
- Este aparelho foi concebido para conectar a uma torneira de água e regular automaticamente o caudal da água no sistema de irrigação.

Proteção do meio-ambiente



Os materiais de embalagem são recicláveis. Não coloque as embalagens no lixo doméstico, envie-as para uma unidade de reciclagem.



Os aparelhos velhos contêm materiais preciosos e recicláveis e deverão ser reutilizados. Por isso, elimine os aparelhos velhos através de sistemas de recolha de lixo adequados.

Avisos sobre os ingredientes (REACH)

Informações actuais sobre os ingredientes podem ser encontradas em:

www.kaercher.de/REACH

Garantia

Em cada país vigem as respectivas condições de garantia estabelecidas pelas nossas Empresas de Comercialização. Eventuais avarias no aparelho durante o período de garantia serão reparadas, sem encargos para o cliente, desde que se trate dum defeito de material ou de fabricação. Em caso de garantia, dirija-se, munido do documento de compra, ao seu revendedor ou ao Serviço Técnico mais próximo. (Endereços no verso)

Símbolos no Manual de Instruções

CUIDADO

Para uma possível situação perigosa que pode conduzir a ferimentos leves ou danos materiais.

Avisos de segurança

CUIDADO

- Não operar o aparelho de irrigação em sistemas de água potável.
- Operar o aparelho de irrigação apenas com água limpa, não tratada, com uma temperatura máx. de 35 °C.
- Instalar o aparelho de irrigação apenas no exterior.
- Não expor o aparelho de irrigação a jactos de água directos, nem mergulhá-lo na água.
- Controlar o aparelho de irrigação antes de cada utilização quanto a danos e imobilizar o sistema se forem detectados defeitos.
- Fixar o aparelho de irrigação apenas em posição vertical.
- Não utilizar massa de vedação nem lubrificantes para conectar o aparelho de irrigação à torneira.
- Não puxar pela mangueira conectada.
- Utilizar apenas baterias de 9V (tipo 6LR61).
- Não instalar o aparelho de irrigação em locais onde é formada água de condensação, visto que esta pode danificar a bateria.
- Não instalar o aparelho de irrigação na proximidade de fontes de calor (temperatura ambiente máxima: 60°C).
- Não operar o aparelho de irrigação na proximidade de aparelhos sob tensão.

Manuseamento

Ao desembalar verifique a integridade do conteúdo da embalagem e eventuais danos. No caso de danos ou falta de material, informe o seu revendedor.

Ver figuras na página desdobrável!



Descrição da máquina

Figuras veja página 2

- 1 Peça redutora (G $\frac{3}{4}$)
- 2 Ligação da água (G 1) com junta de filtro
- 3 Unidade de válvulas
- 4 Conexão de mangueira
- 5 Peça de acoplamento para ligação de mangueira
- 6 Unidade de comando
- 7 Compartimento da bateria
- 8 Display
- 9 Campo de teclas

Descrição do display

Figuras, ver página 3

- 1 Barra do menu
- 2 Irrigação automática
- 3 Irrigação manual
- 4 Função de contagem decrescente da irrigação
- 5 Interrupção da irrigação
- 6 Estado da bateria da unidade de comando
- 7 Indicação do dia da semana
- 8 Indicação do programa de irrigação (activada / desactivada)
- 9 Tempo de irrigação
- 10 A indicação de irrigação está activada
- 11 Tecla de confirmação da activação / desactivação da irrigação
- 12 Menu / tecla Esc
- 13 Tecla OK
- 14 Teclas de setas
- 15 Hora / Tempo de irrigação
- 16 Indicação do tempo de irrigação
- 17 Indicação do tempo actual
- 18 Período de irrigação (manhã / noite)

Funcionamento

O aparelho tem 4 modos.

Irrigação automática

- Com esta função, é possível ajustar os períodos de irrigação individualmente e a irrigação é activada e desactivada automaticamente.

Irrigação manual

- Com esta função, a irrigação é ligada ou desligada manualmente.

Função de contagem decrescente da irrigação

- Com esta função, a irrigação é desligada automaticamente após o tempo indicado (máx. 120 minutos).

Interrupção da irrigação

- Com esta função, a irrigação automática é interrompida durante 24 horas.

Antes de colocar em funcionamento

- A torneira deve estar fechada.
- Enroscar a peça de acoplamento na ligação da mangueira.
- Se necessário, enroscar a peça redutora na ligação da água.
- Segurar a unidade de válvulas na carcaça e enroscar a ligação de água na torneira.





CUIDADO

Nunca ligar o aparelho de irrigação à torneira sem a junta de filtro incluída no volume de fornecimento.

Preparação da unidade de comando

	<p>Aviso: A bateria não está incluída no volume de fornecimento.</p> <p>➔ Inserir a bateria correctamente (+/-) no compartimento da bateria.</p>
	<p>■ Assim que a bateria estiver inserida, a indicação avança automaticamente para o modo de ajuste da hora actual e do dia da semana (após um curto autodiagnóstico). As horas piscam.</p>

Na primeira colocação em funcionamento, ajustar a hora







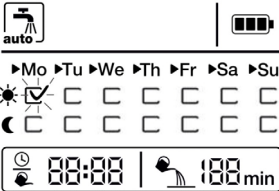

	<p>Aviso: assim que a bateria tiver sido inserida, a hora pisca automaticamente.</p>
	<p>➔ Ajustar as horas com as teclas de seta.</p>
	<p>➔ Confirmar com a tecla OK.</p> <p>Os minutos piscam.</p>
	<p>➔ Ajustar os minutos com as teclas de seta.</p>
	<p>➔ Confirmar com a tecla OK.</p> <p>■ A hora está ajustada.</p>

Na primeira colocação em funcionamento, ajustar o dia da semana

<p>►Mo Tu We Th Fr Sa Su</p> <p>☀</p> <p>☾</p>	<p>Indicação: Segunda-feira a Domingo</p>
<p>← →</p>	<p>→ Ajustar o dia da semana com as teclas de seta.</p>
<p>Ok</p>	<p>→ Confirmar com a tecla OK.</p> <p>■ O dia da semana está ajustado.</p>

Ajuste da irrigação automática





<p> auto</p> <p>►Mo ►Tu ►We ►Th ►Fr ►Sa ►Su</p> <p>☀ <input checked="" type="checkbox"/> <input type="checkbox"/> <input type="checkbox"/> <input type="checkbox"/> <input type="checkbox"/> <input type="checkbox"/> <input type="checkbox"/></p> <p>☾ <input type="checkbox"/> <input type="checkbox"/> <input type="checkbox"/> <input type="checkbox"/> <input type="checkbox"/> <input type="checkbox"/> <input type="checkbox"/></p> <p>🕒 00:00 🕒 00 min</p>	<p>A indicação "Irrigação" pisca (activada)</p> <p>Aviso O período e a duração da irrigação estão configurados de fábrica do seguinte modo: manhã, 6:00, 5 minutos; noite, 21:00, 5 minutos.</p>
<p>← →</p>	<p>Com as teclas de seta é possível navegar através do programa de irrigação.</p>
<p>☑</p>	<p>→ Com a tecla de confirmação, assinalar a activação / desactivação da irrigação.</p> <p>Se a hora e duração predefinidas estiverem correctas, é possível seleccionar outros períodos de irrigação através das teclas de seta.</p> <p>Aviso Com a tecla ESC/MENU é possível abandonar o modo de ajuste a qualquer momento.</p>

	<p>Se a hora e duração predefinidas não estiverem correctas:</p> <p>→ confirmar com a tecla OK para alterar a hora e duração do período de irrigação activo.</p> <p><i>As horas piscam.</i></p>
	<p>→ Ajustar as horas com as teclas de seta.</p>
	<p>→ Confirmar com a tecla OK.</p> <p><i>Os minutos piscam.</i></p>
	<p>→ Ajustar os minutos com as teclas de seta.</p>
	<p>→ Confirmar com a tecla OK.</p> <p><i>A duração da irrigação pisca.</i></p>
	<p>→ Ajustar os minutos com as teclas de seta.</p>
	<p>→ Confirmar com a tecla OK.</p> <ul style="list-style-type: none"> ■ O tempo de irrigação está ajustado. ■ Agora é possível ajustar outros períodos de irrigação através das teclas de seta.
	<p>→ Abandonar o modo de ajuste com a tecla ESC/MENU.</p> <p><i>A irrigação automática está activada.</i></p>







Aviso

Para a alteração posterior dos ajustes, utilizar a tecla ESC/MENU e as teclas de seta para comutar para o modo de ajuste da irrigação automática.





Ajuste da irrigação manual

	<p>→ Mudar para o modo de ajuste com a tecla ESC/MENU.</p>
	<p>O símbolo para a irrigação manual pisca.</p>
	<p>→ Confirmar com a tecla OK.</p>
	<p>É exibido o símbolo da irrigação.</p> <ul style="list-style-type: none"> ■ A válvula abre. ■ A irrigação está activa.
	<p>→ Com a tecla ESC/MENU, a válvula fecha e é comutado para o modo automático.</p> <p>→ Com a tecla OK a válvula fecha, é comutado para o modo de ajuste e não é possível seleccionar uma nova função.</p>

Ajuste da função de contagem decrescente da irrigação

	<p>→ Mudar para o modo de ajuste com a tecla ESC/MENU.</p>
	<p>→ Seleccionar o modo de irrigação com as teclas de seta.</p>
	<p><i>O símbolo para a função de contagem decrescente pisca.</i></p>
	<p>→ Confirmar com a tecla OK.</p> <p><i>Os minutos piscam.</i></p>
	<p>→ Ajustar os minutos com as teclas de seta.</p>
	<p>→ Confirmar com a tecla OK.</p>
	<p><i>É exibido o símbolo da irrigação.</i></p> <ul style="list-style-type: none"> ■ A função de contagem decrescente está activada. ■ A válvula abre. ■ A irrigação está activa. <p><i>Após a conclusão da contagem decrescente, a função comuta para o modo automático.</i></p>
	<p>Para uma conclusão prematura:</p> <p>→ Com a tecla ESC/MENU, a válvula fecha e é comutado para o modo automático.</p> <p>→ Com a tecla OK a válvula fecha, é comutado para o modo de ajuste e não é possível seleccionar uma nova função.</p>

Interrupção da irrigação

	→ Mudar para o modo de ajuste com a tecla ESC/MENU .
	→ Seleccionar o modo de irrigação com as teclas de seta.
	<i>O símbolo para a interrupção da irrigação pisca.</i>
	→ Confirmar com a tecla OK . ■ O ajuste de irrigação está desactivado durante 24 horas.
	→ Para a conclusão antes de terem decorrido as 24 horas, é possível interromper a função através da tecla OK ou ESC/MENU , sendo comutado para o modo automático.

Funcionamento

- Colocar a unidade de comando na unidade de válvulas.
- Abrir a torneira.

Desligar o aparelho

No final da estação de rega



- Fechar a torneira de água.
- Separar o aparelho de irrigação da torneira da água e da mangueira da água.
- A unidade de comando deve permanecer conectada com a unidade de válvulas.
- Activar a irrigação manual para permitir a saída da água residual do aparelho de irrigação.
- Separar a unidade de comando da unidade de válvulas.
- Retirar a bateria.
- Guardar o aparelho de irrigação num local seco e protegido contra geada.

Conservação e manutenção

Limpar a junta de filtro

- Retirar a junta de filtro regularmente da ligação da água e lavar sob água corrente.

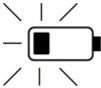
Bateria

	Estado da bateria: cheia
	Estado da bateria: quase vazia → Substituir a bateria.
	Estado da bateria: vazia → Substituir a bateria. Aviso Por questões de segurança, no modo "Irrigação automática" a válvula é fechada. A irrigação já não pode ser activada.

Substituir bateria

- Remover a unidade de comando.
- Inserir uma nova bateria de 9V (tipo 6LR61).
Eliminar a bateria gasta de acordo com a legislação em vigor.
- Colocar a unidade de comando na unidade de válvulas e prestar atenção quanto a uma fixação correcta.

Aviso

A bateria antiga pode ser substituída por uma bateria nova, no espaço de 3 minutos, sem que os ajustes de irrigação e a programação sejam perdidos.

Tipos de bateria utilizáveis:

- Alcalino
- Bateria recarregável com auto-descarga baixa e uma capacidade de, pelo menos, 250 mAh.

Aviso

As baterias recarregáveis não duram uma temporada inteira.

Manutenção

O aparelho está isento de manutenção.

Ajuda em caso de avarias

Avaria	Causa	Eliminação da avaria
Irrigação não funciona apesar da programação.	Torneira da água fechada.	Abrir a torneira.
	Bateria descarregada.	Inserir uma nova bateria de 9V (tipo 6LR61).
	Contactos da bateria oxidados.	Limpar os contactos.
	Junta de filtro entupida.	Limpar a junta de filtro.
A válvula não abre/fecha.	Com a unidade de comando desmontada não é possível abrir/fechar a válvula.	Colocar a unidade de comando na unidade de válvulas.
Nenhuma indicação no display	Bateria descarregada ou contacto oxidado.	Inserir uma nova bateria de 9V (tipo 6LR61) ou limpar os contactos.
Fuga na ligação da água.	Junta de filtro com defeito.	Substituir a junta de filtro.
	A ligação da água, na torneira, soltou-se.	Voltar a apertar a ligação da água.

Em caso de dúvidas ou avarias, a nossa filial Kärcher local está à sua disposição. Endereços no verso.

Executar um Reset

→ Retirar a bateria do compartimento da bateria até a indicação no display desaparecer totalmente.

ou

→ Se a tecla OK for premida durante 5 segundos, o ajuste é reposto.

Dados técnicos

Pressão de serviço	0,1 - 1,0 (1 - 10)	MPa (bar)
Temperatura de admissão (máx.)	35	°C
Temperatura ambiente	+1 -> +60	°C
Tipo de bateria	9V (6LR61 / alcalina)	
	9V (dimensão construtiva como: 6LR61 / bateria recarregável com auto-descarga baixa e uma capacidade de, pelo menos, 250 mAh)	

O fabricante reserva-se o direito de proceder a quaisquer alterações técnicas.

Πίνακας περιεχομένων

Γενικές υποδείξεις	83
Υποδείξεις ασφαλείας	84
Χειρισμός	84
Φροντίδα και συντήρηση	92
Αντιμετώπιση βλαβών	93
Τεχνικά χαρακτηριστικά	93

Γενικές υποδείξεις

Προς την αξιότιμη πελατεία μας



Πριν χρησιμοποιήσετε τη συσκευή σας για πρώτη φορά, διαβάστε αυτές τις πρωτότυπες οδηγίες χρήσης, ενεργήστε σύμφωνα με αυτές και κρατήστε τις για μελλοντική χρήση ή για τον επόμενο ιδιοκτήτη.

Αρμόζουσα χρήση

- Η παρούσα συσκευή σχεδιάστηκε ειδικά για ιδιωτική χρήση και δεν είναι σε θέση να ανταποκριθεί στις καταπονήσεις που συνεπάγεται μία ενδεχόμενη επαγγελματική της χρήση.
- Αυτή η συσκευή προορίζεται για σύνδεση σε βάνα νερού και ρυθμίζει αυτόματα τη ροή νερού στο σύστημα άρδευσης.

Προστασία περιβάλλοντος



Τα υλικά συσκευασίας είναι ανακυκλώσιμα. Μην πετάτε τη συσκευασία στα οικιακά απορρίμματα, αλλά παραδώστε την προς ανακύκλωση.



Οι παλιές συσκευές περιέχουν ανακυκλώσιμα υλικά, τα οποία θα πρέπει να παραδίδονται προς επαναχρησιμοποίηση. Για το λόγο αυτό αποσύρετε τις παλιές συσκευές με κατάλληλες διαδικασίες συγκέντρωσης αποβλήτων.

Υποδείξεις για τα συστατικά (REACH)

Ενημερωμένες πληροφορίες για τα συστατικά μπορείτε να βρείτε στη διεύθυνση:
www.kaercher.de/REACH

Εγγύηση

Σε κάθε χώρα ισχύουν οι όροι εγγύησης που εκδόθηκαν από την αρμόδια εταιρία μας προώθησης πωλήσεων. Αναλαμβάνουμε τη δωρεάν αποκατάσταση οποιασδήποτε βλάβης στη συσκευή σας, εφόσον οφείλεται σε αστοχία υλικού ή κατασκευαστικό σφάλμα, εντός της προθεσμίας που ορίζεται στην εγγύηση. Σε περίπτωση που επιθυμείτε να κάνετε χρήση της εγγύησης, παρακαλούμε απευθυνθείτε με την απόδειξη αγοράς στο κατάστημα από το οποίο προμηθευτήκατε τη συσκευή ή στην πλησιέστερη εξουσιοδοτημένη υπηρεσία τεχνικής εξυπηρέτησης πελατών μας. (Για τη διεύθυνση βλ. στην πίσω σελίδα)

Σύμβολα στο εγχειρίδιο οδηγιών

ΠΡΟΣΟΧΗ

Για ενδεχόμενη επικίνδυνη κατάσταση, η οποία μπορεί να οδηγήσει σε ελαφρό τραυματισμό ή υλικές βλάβες.

Υποδείξεις ασφαλείας

ΠΡΟΣΟΧΗ

- Μην χρησιμοποιείτε το αυτόματο σύστημα άρδευσης σε συστήματα πόσιμου νερού.
- Χρησιμοποιείτε το αυτόματο σύστημα άρδευσης μόνον με μη επεξεργασμένο, καθαρό γλυκό νερό με θερμοκρασία έως 35?.
- Εγκαταστήστε το αυτόματο σύστημα άρδευσης μόνον σε εξωτερικό χώρο.
- Μην εκθέτετε το αυτόματο σύστημα άρδευσης απευθείας σε δέσμη νερού και μην το βυθίζετε ποτέ σε νερό.
- Ελέγχετε το αυτόματο σύστημα άρδευσης για τυχόν βλάβες πριν από κάθε χρήση και διακόψτε τη λειτουργία του, εάν διαπιστώσετε ορατές βλάβες.
- Τοποθετήστε το αυτόματο σύστημα άρδευσης μόνον σε όρθια θέση.
- Μην χρησιμοποιείτε παχύρρευστες ουσίες και λιπαντικά για τη σύνδεση του αυτόματου συστήματος άρδευσης στη βάνα νερού.
- Μην τραβάτε το συνδεδεμένο ελαστικό σωλήνα.
- Χρησιμοποιείτε μόνον μπαταρίες 9V (τύπος 6LR61).
- Μην εγκαθιστάτε το αυτόματο σύστημα άρδευσης σε σημεία, όπου υπάρχει νερό συμπυκνώματος, καθώς ενδέχεται να προκληθούν βλάβες στη μπαταρία.
- Μην εγκαθιστάτε το αυτόματο σύστημα άρδευσης κοντά σε πηγές θερμότητας (μέγιστη θερμοκρασία περιβάλλοντος 60?).
- Μην χρησιμοποιείτε το αυτόματο σύστημα άρδευσης πλάι σε συσκευές υπό τάση.

Χειρισμός

Κατά την αποσυσκευασία ελέγξτε το περιεχόμενο της συσκευασίας για ελλείψεις και βλάβες. Σε περίπτωση παραπόνων ενημερώστε το κατάστημα.

Εικόνες, βλ. αναδιπλούμενη σελίδα!



Περιγραφή της συσκευής

Εικόνες, βλ. σελίδα 2

- 1 Τεμάχιο μείωσης (G 3/4)
- 2 Σύνδεση νερού (G 1) με μόνωση φίλτρου
- 3 Συγκρότημα βαλβίδας
- 4 Σύνδεση λάστιχου
- 5 Σύζευξη για σύνδεση ελαστικού σωλήνα
- 6 Μονάδα χειρισμού
- 7 Θήκη μπαταριών
- 8 Ένδειξη οθόνης
- 9 Πληκτρολόγιο

Περιγραφή οθόνης

Εικόνες, βλ. σελίδα 3

- 1 Γραμμή μενού
- 2 Αυτόματη άρδευση
- 3 Μη αυτόματη άρδευση
- 4 Λειτουργία Countdown άρδευσης
- 5 Διακοπή άρδευσης
- 6 Κατάσταση μπαταρίας χειριστηρίου
- 7 Ένδειξη ημέρας
- 8 Ένδειξη προγράμματος άρδευσης (ενεργοποίηση/απενεργοποίηση)
- 9 Διάρκεια άρδευσης
- 10 Ένδειξη ενεργούς άρδευσης
- 11 Πλήκτρο επιβεβαίωσης ενεργοποίησης/απενεργοποίησης άρδευσης
- 12 Μενού / πλήκτρο esc
- 13 Πλήκτρο ok
- 14 Πλήκτρα με βέλη
- 15 Ώρα / Ώρα άρδευσης
- 16 Ένδειξη χρόνου άρδευσης
- 17 Ένδειξη τρέχουσας ώρας
- 18 Χρονικό διάστημα άρδευσης (πρωί/βράδυ)

Λειτουργία

Η συσκευή διαθέτει 4 λειτουργίες.

Αυτόματη άρδευση

- Με αυτήν τη λειτουργία μπορείτε να ρυθμίσετε τα μεμονωμένα χρονικά διαστήματα άρδευσης και να ενεργοποιήσετε ή να απενεργοποιήσετε αυτόματα την άρδευση.

Μη αυτόματη άρδευση

- Με αυτήν τη λειτουργία μπορείτε να ενεργοποιήσετε ή να απενεργοποιήσετε μη αυτόματα την άρδευση.

Λειτουργία Countdown άρδευσης

- Με αυτήν τη λειτουργία μπορείτε να απενεργοποιήσετε αυτόματα την άρδευση έπειτα από τον επιθυμητό χρόνο (έως 120 λεπτά).

Διακοπή άρδευσης

- Με αυτήν τη λειτουργία μπορείτε να απενεργοποιήσετε την αυτόματη άρδευση για 24 ώρες.



Πριν τη θέση σε λειτουργία

- Η βάνα νερού πρέπει να είναι κλειστή.
- Βιδώστε τη σύζευξη στη σύνδεση ελαστικού σωλήνα.
- Βιδώστε το τεμάχιο μείωσης στη σύνδεση νερού.
- Κρατήστε τη μονάδα βαλβίδας στο περίβλημα και βιδώστε τη σύνδεση νερού στη βάνα.





ΠΡΟΣΟΧΗ

Μην συνδέετε ποτέ το αυτόματο σύστημα άρδευσης στη βάνα χωρίς τη συνοδευτική μόνωση φίλτρου.

Προετοιμασία μονάδας χειρισμού

	<p>Υπόδειξη: Η μπαταρία δεν περιλαμβάνεται στη συσκευασία.</p> <p>➔ Τοποθετήστε την μπαταρία στη σωστή θέση (σημάδια +/-) στη θήκη της.</p>
	<ul style="list-style-type: none"> ■ Μόλις τοποθετηθεί η μπαταρία, εκτελείται ένας σύντομος αυτοέλεγχος και εμφανίζεται αμέσως η ένδειξη της κατάστασης ρύθμισης της τρέχουσας ώρας και ημέρας. Οι ώρες της ένδειξης ώρας αναβοσβήνουν.



Ρύθμιση ώρας κατά την πρώτη ενεργοποίηση









	<p>Υπόδειξη: Μόλις τοποθετηθεί η μπαταρία, θα αρχίσει να αναβοσβήνει αυτόματα η ώρα.</p>
	<p>➔ Ρυθμίστε τις ώρες με τα πλήκτρα βέλους.</p>
	<p>➔ Επιβεβαιώστε με το πλήκτρο OK.</p> <p><i>Τα λεπτά αναβοσβήνουν.</i></p>
	<p>➔ Ρυθμίστε τα λεπτά με τα πλήκτρα βέλους.</p>
	<p>➔ Επιβεβαιώστε με το πλήκτρο OK.</p> <ul style="list-style-type: none"> ■ Η ώρα έχει ρυθμιστεί.

Ρύθμιση ημέρας κατά την πρώτη ενεργοποίηση





<p>►Mo Tu We Th Fr Sa Su</p> <p>☀</p> <p>☾</p>	<p>Ένδειξη: Δευτέρα έως Κυριακή</p>
<p>← →</p>	<p>➔ Ρυθμίστε την ημέρα με τα πλήκτρα βέλους.</p>
<p>Ok</p>	<p>➔ Επιβεβαιώστε με το πλήκτρο OK.</p> <ul style="list-style-type: none"> ■ Η ημέρα έχει ρυθμιστεί.

Ρύθμιση αυτόματης άρδευσης







<p> auto</p> <p>►Mo ►Tu ►We ►Th ►Fr ►Sa ►Su</p> <p>☀ <input checked="" type="checkbox"/> <input type="checkbox"/> <input type="checkbox"/> <input type="checkbox"/> <input type="checkbox"/> <input type="checkbox"/> <input type="checkbox"/></p> <p>☾ <input type="checkbox"/> <input type="checkbox"/> <input type="checkbox"/> <input type="checkbox"/> <input type="checkbox"/> <input type="checkbox"/> <input type="checkbox"/></p> <p> 00:00  00 min</p>	<p>Αναβοσβήνει η ένδειξη άρδευσης (ενεργή)</p> <p>Υπόδειξη Η εργοστασιακή ρύθμιση για το χρόνο και τη διάρκεια άρδευσης είναι το πρωί στις 6:00 για 5 λεπτά και το βράδυ στις 21:00 για 5 λεπτά.</p>
<p>← →</p>	<p>Με τα πλήκτρα βέλους μπορείτε να περιηγηθείτε στο πρόγραμμα άρδευσης.</p>
<p><input checked="" type="checkbox"/></p>	<p>➔ Επισημάνετε με το πλήκτρο επιβεβαίωσης την ενεργοποίηση/απενεργοποίηση της άρδευσης.</p> <p>Εάν η προεπιλεγμένη ώρα και διάρκεια είναι σωστή, μπορείτε να επιλέξετε περισσότερα διαστήματα άρδευσης με τα πλήκτρα βέλους.</p> <p>Υπόδειξη Μπορείτε να εξέλθετε από τη λειτουργία ρύθμισης οποιαδήποτε στιγμή με το πλήκτρο esc/μενού.</p>

	<p>Εάν η προεπιλεγμένη ώρα και διάρκεια δεν είναι σωστή:</p> <p>➔ Επιβεβαιώστε με το πλήκτρο OK, προκειμένου να αλλάξετε την ώρα και τη διάρκεια του ενεργού διαστήματος άρδευσης.</p> <p><i>Οι ώρες αναβοσβήνουν.</i></p>
	<p>➔ Ρυθμίστε τις ώρες με τα πλήκτρα βέλους.</p>
	<p>➔ Επιβεβαιώστε με το πλήκτρο OK.</p> <p><i>Τα λεπτά αναβοσβήνουν.</i></p>
	<p>➔ Ρυθμίστε τα λεπτά με τα πλήκτρα βέλους.</p>
	<p>➔ Επιβεβαιώστε με το πλήκτρο OK.</p> <p><i>Η διάρκεια άρδευσης αναβοσβήνει.</i></p>
	<p>➔ Ρυθμίστε τα λεπτά με τα πλήκτρα βέλους.</p>
	<p>➔ Επιβεβαιώστε με το πλήκτρο OK.</p> <ul style="list-style-type: none"> ■ Η διάρκεια άρδευσης έχει ρυθμιστεί. ■ Με τα πλήκτρα βέλους μπορούν να ρυθμιστούν μόνο δύο πρόσθετα χρονικά διαστήματα άρδευσης.
	<p>➔ Εξέλθετε από τη λειτουργία ρύθμισης με το πλήκτρο esc/μενού.</p> <p><i>Η αυτόματη άρδευση είναι ενεργοποιημένη.</i></p>
<p>Υπόδειξη Για αλλαγή των ρυθμίσεων σε μεταγενέστερο χρόνο, μεταβείτε στη λειτουργία ρύθμισης της αυτόματης άρδευσης με το πλήκτρο esc/μενού και τα πλήκτρα βέλους.</p>	





Ρύθμιση μη αυτόματης άρδευσης

	<p>→ Μεταβείτε στη λειτουργία ρύθμισης με το πλήκτρο esc/μενού.</p>
	<p>Αναβοσβήνει το σύμβολο μη αυτόματης άρδευσης.</p>
	<p>→ Επιβεβαιώστε με το πλήκτρο OK.</p>
	<p>Εμφανίζεται το σύμβολο άρδευσης.</p> <ul style="list-style-type: none"> ■ Η βαλβίδα ανοίγει. ■ Η άρδευση είναι ενεργή.
	<p>→ Η βαλβίδα κλείνει με το πλήκτρο esc/μενού και εμφανίζεται η αυτόματη λειτουργία.</p> <p>→ Με το πλήκτρο OK κλείνει η βαλβίδα, ανοίγει η λειτουργία ρύθμισης και παρέχεται η δυνατότητα επιλογής μιας νέας λειτουργίας.</p>

Ρύθμιση λειτουργίας Countdown άρδευσης

	<p>➔ Μεταβείτε στη λειτουργία ρύθμισης με το πλήκτρο esc/μενού.</p>
	<p>➔ Επιλέξτε τη λειτουργία άρδευσης με τα πλήκτρα βέλους.</p>
	<p>Αναβοσβήνει το σύμβολο της λειτουργίας Countdown.</p>
	<p>➔ Επιβεβαιώστε με το πλήκτρο OK.</p> <p>Τα λεπτά αναβοσβήνουν.</p>
	<p>➔ Ρυθμίστε τα λεπτά με τα πλήκτρα βέλους.</p>
	<p>➔ Επιβεβαιώστε με το πλήκτρο OK.</p>
	<p>Εμφανίζεται το σύμβολο άρδευσης.</p> <ul style="list-style-type: none"> ■ Η λειτουργία Countdown είναι ενεργή. ■ Η βαλβίδα ανοίγει. ■ Η άρδευση είναι ενεργή. <p>Μετά το πέρας του Countdown ανοίγει η αυτόματη λειτουργία.</p>
	<p>Για πρόωρο τερματισμό:</p> <p>➔ Η βαλβίδα κλείνει με το πλήκτρο esc/μενού και εμφανίζεται η αυτόματη λειτουργία.</p> <p>➔ Με το πλήκτρο OK κλείνει η βαλβίδα, ανοίγει η λειτουργία ρύθμισης και παρέχεται η δυνατότητα επιλογής μιας νέας λειτουργίας.</p>

Διακοπή άρδευσης

	→ Μεταβείτε στη λειτουργία ρύθμισης με το πλήκτρο esc/μενού .
	→ Επιλέξτε τη λειτουργία άρδευσης με τα πλήκτρα βέλους.
	Αναβοσβήνει το σύμβολο διακοπής της άρδευσης.
	→ Επιβεβαιώστε με το πλήκτρο OK . ■ Η ρύθμιση άρδευσης απενεργοποιείται για 24 ώρες.
	→ Για τον τερματισμό της 24ωρης διαδικασίας μπορείτε να διακόψετε τη λειτουργία με το πλήκτρο OK ή το πλήκτρο esc/μενού και να μεταβείτε στην αυτόματη λειτουργία.

Λειτουργία

- Τοποθετήστε τη μονάδα χειρισμού πάνω στη μονάδα βαλβίδας.
- Ανοίξτε τον κρουνο.

Τερματισμός λειτουργίας

Στο τέλος της σεζόν άρδευσης



- Κλείστε τη βάνα νερού.
- Αποσυνδέστε το αυτόματο σύστημα άρδευσης από τη βάνα νερού και τον ελαστικό σωλήνα νερού.
- Η μονάδα χειρισμού πρέπει να παραμείνει συνδεδεμένη με τη μονάδα βαλβίδας.
- Ενεργοποιήστε τη μη αυτόματη άρδευση, ώστε να εκρεύσει από το αυτόματο σύστημα άρδευσης το νερό που έχει απομείνει.
- Αποσυνδέστε τη μονάδα χειρισμού από τη μονάδα βαλβίδας.
- Αφαιρέστε τη μπαταρία.
- Φυλάξτε το αυτόματο σύστημα άρδευσης σε ξηρό χώρο που προστατεύεται από τον παγετό.

Φροντίδα και συντήρηση

Καθαρισμός της μόνωσης φίλτρου

- ➔ Αφαιρείτε τακτικά τη μόνωση φίλτρου της σύνδεσης νερού και ξεπλένετέ την με τρεχούμενο νερό.

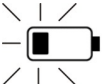
Μπαταρία

	Φορτισμένη μπαταρία
	Σχεδόν κενή μπαταρία ➔ Αντικαταστήστε την μπαταρία.
	Κενή μπαταρία ➔ Αντικαταστήστε την μπαταρία. Υπόδειξη Στη λειτουργία αυτόματης άρδευσης, η βαλβίδα είναι κλειστή για λόγους ασφαλείας. Η άρδευση δεν μπορεί πλέον να ενεργοποιηθεί.

Αντικαταστήστε τη μπαταρία

- ➔ Αφαιρέστε τη μονάδα χειρισμού.
- ➔ Τοποθετήστε μια καινούρια μπαταρία 9V (τύπος 6LR61). Διαθέστε τις χρησιμοποιημένες μπαταρίες σύμφωνα με τις ισχύουσες διατάξεις.
- ➔ Τοποθετήστε τη μονάδα χειρισμού στη μονάδα βαλβίδας και φροντίστε για την ορθή της έδραση.

Υπόδειξη

Η παλιά μπαταρία μπορεί να αντικατασταθεί εντός 3 λεπτών από μια καινούρια μπαταρία, χωρίς να χαθούν οι ρυθμίσεις άρδευσης και το προγραμματισμός.

Χρησιμοποιούμενοι τύποι μπαταρίας:

- Αλκαλική
- Επαναφορτιζόμενη μπαταρία με ελάχιστη αυτόματη αποφόρτιση και χωρητικότητα τουλάχιστον 250 mAh.

Υπόδειξη

Οι επαναφορτιζόμενες μπαταρίες δεν διαρκούν υπό ορισμένες συνθήκες για ολόκληρη τη σεζόν.

Συντήρηση

Το μηχάνημα δεν χρειάζεται συντήρηση.

Αντιμετώπιση βλαβών

Βλάβη	Αίτιο	Αντιμετώπιση
Η άρδευση δεν πραγματοποιείται παρά τον προγραμματισμό.	Κλειστή βάνα νερού.	Ανοίξτε τη βάνα νερού.
	Άδεια μπαταρία.	Τοποθετήστε μια καινούρια μπαταρία 9V (τύπος 6LR61).
	Οξειδωμένες επαφές σύνδεσης μπαταρίας.	Καθαρίστε τις επαφές.
	Φρασμένη μόνωση φίλτρου.	Καθαρίστε τη μόνωσης φίλτρου.
Η βαλβίδα δεν ανοίγει / δεν κλείνει.	Η βαλβίδα δεν μπορεί να ανοίξει / να κλείσει εάν έχει αφαιρεθεί η μονάδα χειρισμού.	Τοποθετήστε τη μονάδα χειρισμού στη μονάδα βαλβίδας.
Δεν υπάρχει ένδειξη στην οθόνη	Η μπαταρία είναι άδεια ή οι επαφές είναι οξειδωμένες.	Τοποθετήστε μια καινούρια μπαταρία 9V (τύπος 6LR61) ή καθαρίστε τις επαφές.
Διαρροή στη σύνδεση νερού.	Βλάβη στη μόνωση φίλτρου.	Αντικαταστήστε τη μόνωση φίλτρου.
	Αποσυνδέθηκε η διάταξη σύνδεσης νερού στη βάνα.	Σφίξτε ξανά τη σύνδεση νερού.

Σε περίπτωση αποριών ή βλαβών μπορείτε να απευθύνεστε στο πλησιέστερο υποκατάστημα του Οίκου Kdcher, το οποίο θα σας βοηθήσει ευχαρίστως. Για τη διεύθυνση βλ. στην πίσω σελίδα.

Εκτέλεση επαναφοράς

- ➔ Αφαιρέστε την μπαταρία από τη θήκη μπαταριών, ώσπου να σβήσει εντελώς η ένδειξη στην οθόνη.
- ή
- ➔ Οι ρυθμίσεις μηδενίζονται με παρατεταμένη πίεση του πλήκτρου OK για 5 δευτερόλεπτα.

Τεχνικά χαρακτηριστικά

Πίεση λειτουργίας	0,1 - 1,0 (1 - 10)	MPa (bar)
Θερμοκρασία προσαγωγής (μέγ.)	35	°C
Θερμοκρασία περιβάλλοντος	+1 -> +60	°C
Τύπος μπαταρίας	9V (6LR61 / αλκαλική)	
	9V (μέγεθος κατασκευής όπως: 6LR61 / Επαναφορτιζόμενη μπαταρία με ελάχιστη αυτόματη αποφόρτιση και τουλάχιστον 250 mAh)	

Με την επιφύλαξη τεχνικών αλλαγών.

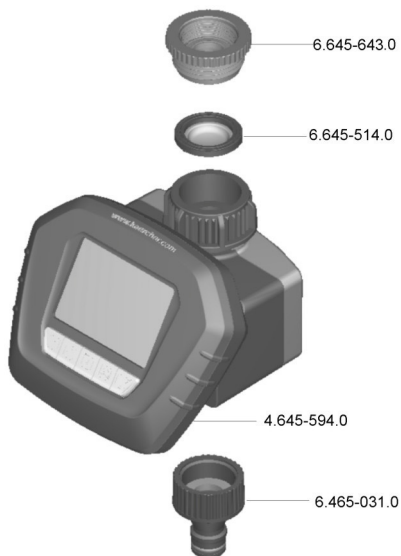



<http://www.kaercher.com/dealersearch>

