

7 T HOLZSPALTER

- Durchtrennt gelagertes sowie frisches Holz mühelos
- Spaltkraft 7 Tonnen
- Max. bis 52 cm Holzlänge, bis 25 cm Durchmesser
- Hydraulikzylinder mit automatischem Rücklauf
- Verwindungssteife, pulverbeschichtete Stahlkonstruktion
- Stabiles Spaltmesser
- Leistungsstarker Motor mit 2200 W
- Stufenlos einstellbarer Spalthub
- Optimale Sicherheit durch die Zwei-Hand-Bedienung
- Wartungsarme Maschine mit geringem Platzbedarf
- Sicherheitsabdeckung um den Spaltbereich
- Ablagetisch für Spaltgut
- Inklusive Untergestell (HL760LS)

Motorleistung



220 - 240 V~ / 50 Hz

2200 W



★★★★

Schutzkäfig
gegen
splitterndes Holz

ANWENDUNGSBESPIELE



Hartholz



Weichholz

PRODUKT-DETAILS

Spaltdurchmesser



55 - 250 mm

Spaltgutgröße

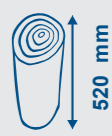

520 mm

Kraftvolle Spaltkraft



max. 7 t

Motorleistung



2200 W

Vario Spalt System

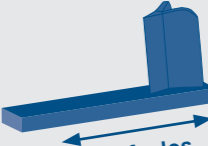

stufenlos

Kompakte Bauweise



Kraftvolle Spaltkraft



max. 7 t



INKLUSIVE

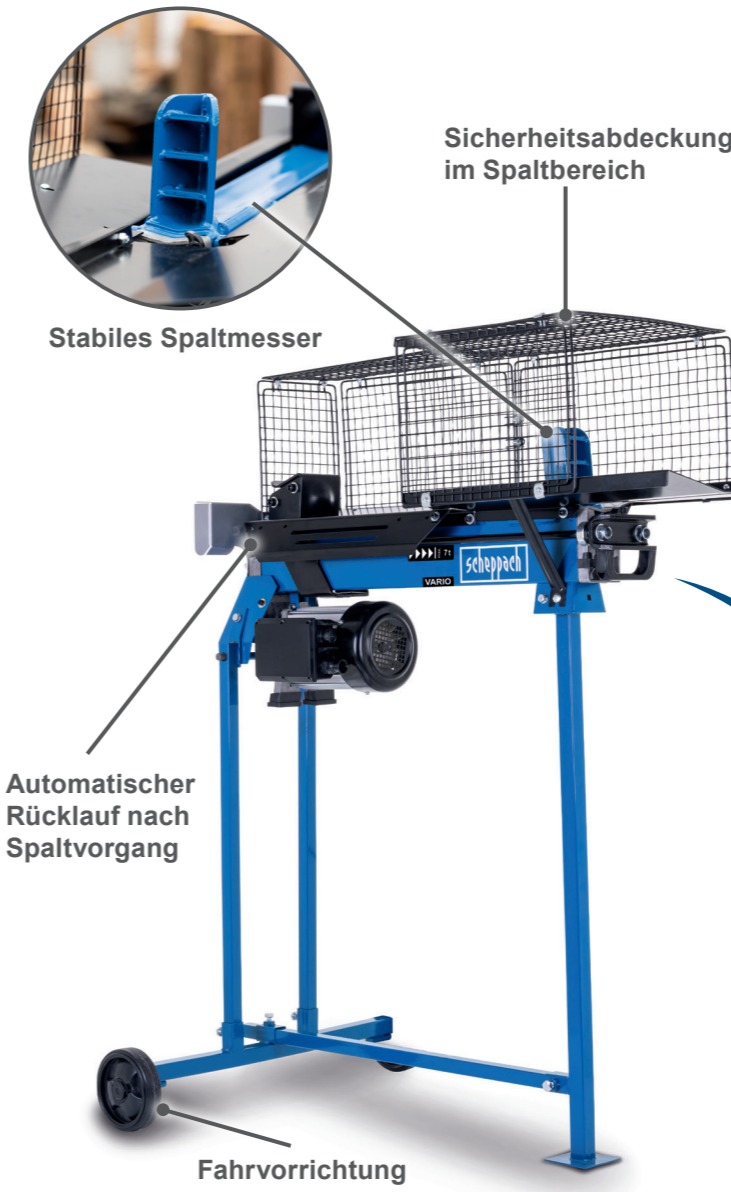
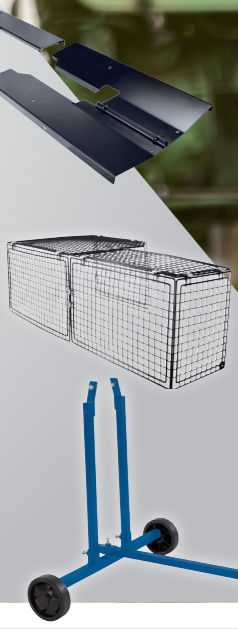

Inklusive Unterstell



nur HL760LS



PRODUKTDATEN

| | |
|---------------------------|--|
| Abmessungen L x B x H | 1160 x 425 x 610 mm (HL760L) 1160 x 725 x 1350 mm (HL760LS) |
| Spaltkraft max. | 7 t |
| Holz-Ø min. – max. | 50 – 250 mm |
| Spaltgutlänge min. – max. | 200 – 520 mm |
| Vorlaufgeschwindigkeit | 3,08 cm/s |
| Rücklaufgeschwindigkeit | 5,29 cm/s |
| Motor | 220 – 240 V~ / 50 Hz |
| Motorleistung | 2200 W |

LOGISTISCHE DATEN

| | HL760LS | HL760L |
|------------------------|--------------------|---------------|
| Gewicht netto / brutto | 59 / 64 kg | 59 / 63 kg |
| Abmessung Verpackung | 950 x 325 x 510 mm | |
| Artikelnummer | 5905211934 | 5905211903 |
| EAN | 4046664120698 | 4046664121787 |
| 20 Container | 168 Stück | 168 Stück |
| 40 Container | 344 Stück | 344 Stück |
| 40 HQ Container | 430 Stück | 430 Stück |

